

Updated and Revised - 2013

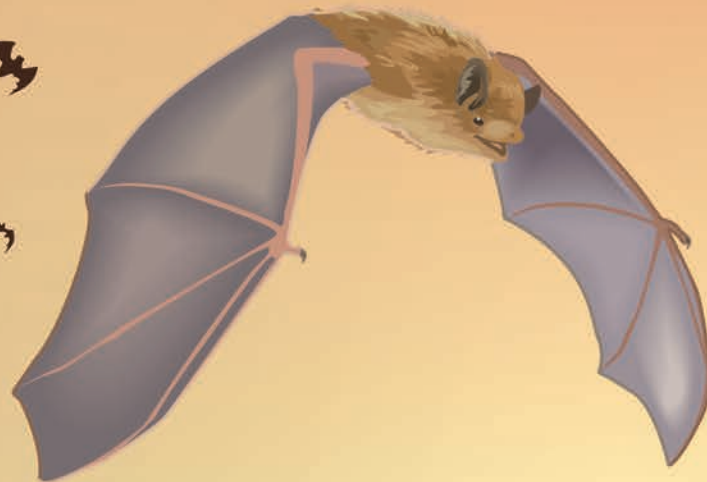

The Bat House Builder's H a n d b o o k

Merlin D. Tuttle
Mark Kiser
Selena Kiser



batcon.org
BAT CONSERVATION
INTERNATIONAL





Dear Friend:

Thank you for your interest in helping bats. Building and installing a bat house can make a difference for bats and help promote a healthy environment. And you can accomplish even more by joining Bat Conservation International.

In addition to funding critical conservation efforts around the world, BCI members receive:

- *BATS* magazine, our quarterly publication filled with full-color photos and the latest discoveries about bats
- Invitations to join workshops, field projects and ecotours, as well as opportunities to see the world's largest bat colony emerge from Bracken Cave in central Texas.

You'll find additional details in this handbook. We hope to hear from you soon.

Sincerely,

Merlin D. Tuttle
*Founder and President
Bat Conservation International
-1993-*

Cover illustration by David Chapman from artwork by Andrea Peyton

Back cover:

The spectacular sight of large numbers of bats in flight across the evening skies used to be far more common. Many North American bats have lost key roosting habitat, from caves to old-growth forests. Erecting bat houses and carefully observing the results give us a unique opportunity to help these magnificent animals.

PHOTO • MERLIN D. TUTTLE, BCI / 8406409

This edition was revised and updated in 2013

by Jim Kennedy, Robert Locke and Dianne Odegard of Bat Conservation International and Laura Seckbach Finn of Fly By Night, Inc.

The Bat House Builder's Handbook

Contents

| | |
|--|----|
| Why Build a Bat House?..... | 4 |
| Building a Community Bat House | 5 |
| Building Your Bat House | 6 |
| Single-chamber Bat House Plans..... | 10 |
| Four-chamber Nursery House Plans | 11 |
| Two-chamber Rocket Box Plans..... | 14 |
| Pointers for Bat House Experimenters | 16 |
| BCI Research Boosts Bat House Success | 18 |
| What We're Learning from Experimentation | 25 |
| Ideas for the Future..... | 28 |
| Troubleshooting Your Bat House | 29 |
| Payoffs of Bat Conservation | 30 |
| Frequently Asked Bat House Questions | 31 |
| Bats Most Likely to Occupy Bat Houses..... | 33 |
| Bats Need Your Help! | 35 |



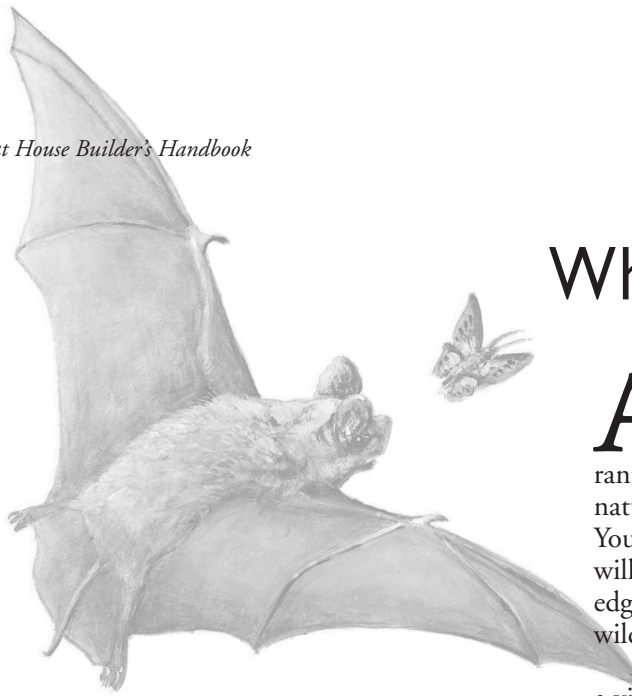

Why Build a Bat House?

AMERICA'S BATS ARE AN ESSENTIAL PART of a healthy environment. Nevertheless, many bat species are in alarming decline, largely because of unwarranted human fear and persecution and the loss of natural roosts. You can help by putting up a bat house. You'll benefit directly from having fewer yard pests and will enjoy learning about bats and sharing your knowledge with friends and neighbors. Few efforts on behalf of wildlife are more fun or rewarding than helping bats.

As primary predators of night-flying insects, bats play a vital role in maintaining the balance of nature. By consuming vast numbers of pests, they rank among humanity's most valuable allies. Just one little brown myotis can catch a thousand or more mosquito-sized insects in an hour, and a colony of 150 big brown bats can catch enough cucumber beetles each summer to prevent egg laying that otherwise could infest local gardens with 33 million rootworms. Cucumber and June beetles, stinkbugs, leafhoppers, and cutworm and corn earworm moths – all well-known pests – are just a few of the many insects consumed by these frequent users of bat houses. In addition, many pests flee areas where they hear bat echolocation sounds.

Our immediate goal is to preserve America's most widespread species in sufficient numbers to maintain nature's balance and reduce demands for chemical pesticides. Thanks to a decade of BCI-sponsored bat house research we are now able to accommodate 14 species of North American bats in the bat houses described in this handbook, including threatened and endangered species such as the Indiana myotis and Wagner's bonneted bat. Bat houses are being used from Mexico and the Caribbean to British Columbia and Newfoundland.

Best of all, if you carefully follow instructions, your odds of success exceed 80 percent. Isn't it about time to extend a helping hand in exchange for a healthier neighborhood?

Bat house designs continue to evolve. Rocket boxes, invented by former U.S. Forest Service biologists Dan Dourson and John MacGregor, are being used by at least eight species of crevice-dwelling bats across North America (Figures 6 and 7, pages 14-15). This design allows bats to choose sunny or shaded sides, depending on their temperature preference.



© MARK & SELENA KISER, BCI / 9166305

Putting up a bat house is one of the more rewarding ways to help wildlife. A maternity colony of several hundred little brown myotis raised young in this back-to-back pair (only one side shown) of nursery houses in British Columbia, Canada. Bat houses like these are now providing shelter for thousands of North American bats each year.

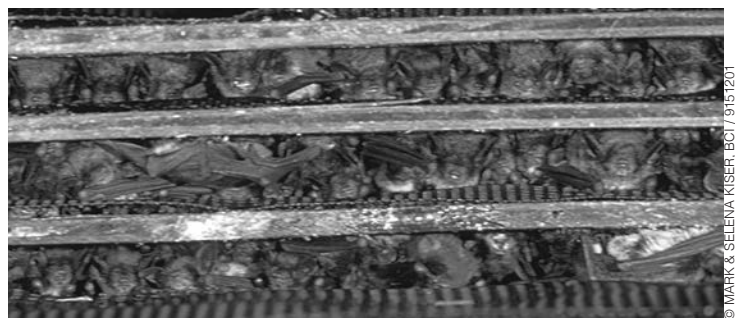

© MARK & SELENA KISER, BCI / 9161201

Building a Community Bat House

SOMETIMES YOU NEED A REALLY BIG BAT HOUSE – one that can handle thousands of bats. BCI can help with that.

As communities become more aware of the importance of bats, humane exclusions are becoming the rule when bat colonies are discovered in buildings. But the displaced bats still need a place to live, and there often are many more bats than traditional bat houses can handle.

BCI worked with architects and engineers to design a "community bat house" that's 10 feet square and mounted on utility poles. With hundreds of removable chambers, the structure can house up to about 30,000 bats.

Initial construction plans have been amended to give the community bat house broader utility and to ensure it meets typical state and local building codes. Several of these structures have been built recently by conservation-minded communities in Florida and Canada.

This "bat condo," based on BCI's plans, can house up to 30,000 bats. It was built at the Creston Valley Wildlife Management Area in British Columbia, Canada.

Construction plans for BCI's community bat house are available free by contacting BCI's Artificial Roosts Coordinator at bathouses@batcon.org



Building Your Bat House

New discoveries greatly enhance our ability to attract bats ...

VOLUNTEERS WITH BCI's Bat House Project conducted research on hundreds of bat houses and other artificial roosts. The designs illustrated on the following pages incorporate the most successful features identified in those tests. The correct bat house for you depends on available tools and lumber, your skill as a carpenter, your budget and your expectations. You can, of course, modify your bat house to adjust for location-specific factors, such as climate and the preferences of local species.

Key Criteria for Successful Bat Houses

Design

The most successful bat houses have roost chambers at least 20 inches tall and at least 14 inches wide. Taller and wider houses are even better. Rocket boxes, a newer pole-mounted design with continuous, 360° chambers, should be at least 3 feet tall (*Figure 6 on page 14*). All houses should have 3- to 6-inch landing areas extending below the entrances or recessed partitions with landing space inside.

The number of roosting chambers is not critical, but in general, the more chambers the better. Single-chambered houses (*Figure 3 on page 10*) should be mounted on wooden or masonry buildings, which helps to buffer temperature fluctuations. Houses with at least three chambers are more likely to provide appropriate ranges of temperature and better accommodate the larger numbers of bats typical of nursery colonies. Two single-chamber houses can be mounted back-to-back on two poles to create a three-chamber bat house.

Our nursery house plans on pages 11-13 (*Figures 4 and 5*) represent the best compromise between bat needs and builder convenience. The 17½-inch width enables builders to make two houses from a half-sheet each of ¾-inch and ½-inch plywood and sharply reduces waste materials. Widths of 24 inches or more and heights of 36 inches or more are preferred by many bats. Greater heights are not often necessary but might be appreciated for their greater thermal gradients.

Roost partitions should be carefully spaced ¾ inch to 1 inch apart. Three-quarter inch is generally preferable, although some small myotis bats and tri-colored bats may prefer roosting crevices between ½ inch and ¾ inch, while

larger bats may prefer 1 inch to 1½ inches. Chambers greater than ¾ inch, however, are more likely to attract non-target animals, such as wasps, rodents and birds.

Partitions and landing areas must be modified to provide footholds for bats. These can be created in various ways. The best method for wooden bat houses is scoring or grooving surfaces horizontally every ¼ to ½ inch. Scoring tools can be made from blocks of wood with screws protruding through one side, or you can use shallow saw cuts ½₂- to ¼₆-inch deep. Do not cut deeper into plywood or it will quickly deteriorate. After roughening, interior plywood surfaces should be protected with dark, water-based stain. Stucco coatings applied to plastic roosting surfaces (after first sanding the plastic) have proven successful for years.

UV-resistant plastic mesh can also be used. We recommend the ⅛-inch- or ¼-inch-square, heavy-duty plastic mesh. The mesh must be securely stapled every two inches across the entire surface and along all edges (do not cover ventilation slots). Mesh is attached to one side of each roost partition and to the backboard and the landing area.

We do not recommend any metal mesh or metal hardware cloth, as these are abrasive and can injure bats. Nylon or fiberglass window screening typically wears out quickly and can trap and kill bats. It is not recommended.

Ventilation slots are critical in houses that will be used where average high temperatures in July are 85°F or above. Half-inch slots should be used to reduce the entry of light and unwanted guests, such as birds. The front vent should extend from side to side about six inches above the bottom (for houses three feet or taller, approximately one-third the distance from the bottom). A vertical vent, ½ inch wide by six inches long, should be included at each end of the rear chamber of multiple-chamber houses.

The vents greatly reduce the odds of overheating on extra hot days and especially contribute to success in moderate or hot climates. They may be unnecessary in exceptionally cool areas.

When nursery houses are mounted in back-to-back pairs on poles (*Figure 2 on page 8*), an additional horizontal vent slot – like the one in front, but ¾ inch tall – should be added in the rear. This slot allows bats to move from one house to the other without going outside. Such an arrangement also provides ideal temperature ranges for nursery colonies.

Construction

For single-chamber and nursery houses (*Figures 3 to 5*), ½-inch (or thicker) exterior plywood is ideal for fronts, backs and roofs, while 1- or 2-inch-thick boards are best for

the sides. One-inch ($\frac{3}{4}$ -inch nominal size) cedar or poplar lumber is recommended for rocket boxes. Roofs for any house type can be built of $\frac{3}{4}$ -inch exterior plywood to increase longevity. Cover roofs with shingles or metal for extra protection. Plywood should have a minimum of four plies for durability. Use of $\frac{3}{4}$ -inch plywood for roosting partitions reduces weight and allows more roosting space for a given house size.

Pressure-treated wood contains chemicals that may be toxic to bats and should be used only if sealed by painting. Alternative materials, such as plastic or fiber-cement board, may last longer than wood and require less maintenance.

Coated deck screws or other exterior-grade screws should be used instead of nails to assemble houses. Staples used to attach plastic mesh should not protrude from the backs of panels and must be exterior grade or galvanized to prevent corrosion. All seams must be caulked, especially around the roof, prior to painting. Latex caulk is paintable and is the easiest to use.

Wood treatment

Bats apparently like dry, non-drafty homes as much as we do, so bat houses need to be carefully caulked and painted. Providing sufficient warmth without overheating is a key element in attracting bats. To protect against moisture, air leaks and wood deterioration, apply one coat of primer to all outer surfaces, including vent openings and landings and entry areas. Follow that with two coats of flat exterior, water-based paint or stain. Do not use oil-based products. Application of two coats of dark paint or stain to inside plywood surfaces prior to assembly greatly extends the life span of the bat house and provides a darker interior.

Research shows that bat houses in cool climates need to absorb much more solar heat than those in hot climates. Houses should be stained or painted black or dark where average high temperatures in July are 85° F or less; dark or medium colors (such as brown, gray or green) at 85-95° F; medium or light colors at 95-100° F; and light or white where July averages exceed 100° F. (See Figure 8 on page 17 for recommended paint colors.) Much depends upon the amount of sun exposure. Darker colors help absorb more heat from less sun.

Sun exposure

When choosing a location for your bat house, both sun exposure and heat absorption (based on house color) must be carefully considered. Too little sun exposure is the most important known cause of bat house failure, even in relatively hot climates as far south as Florida and Texas. Overheating, though a possibility, can be greatly reduced by using ventilation slots (see Design section on page 6). Ventilated houses with tall chambers allow bats to move vertically to find their preferred temperatures through daily

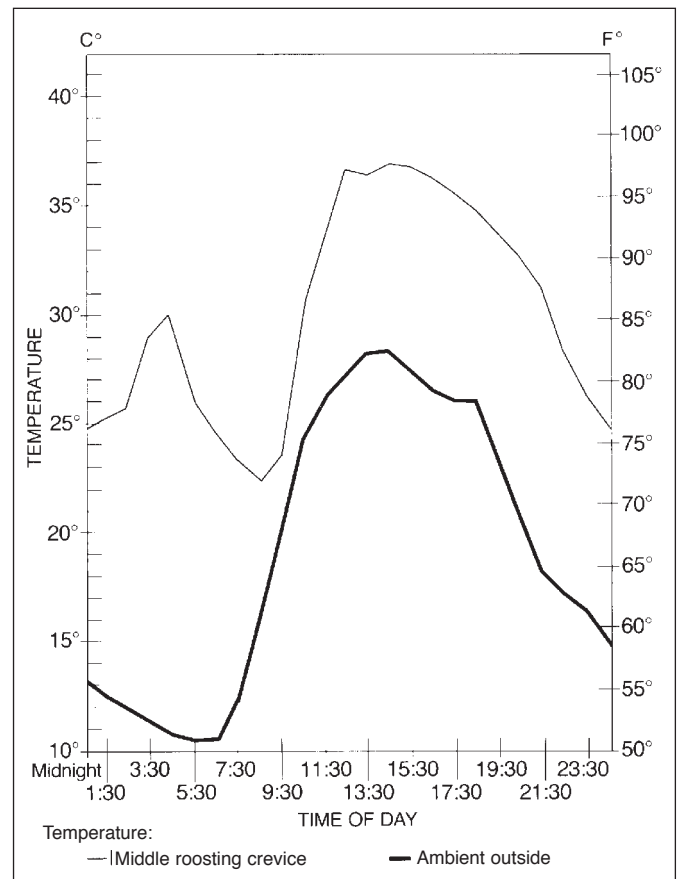

(Courtesy of Lisa Williams, Pennsylvania Game Commission)

FIGURE 1: This graph compares internal and external temperatures over a 24-hour cycle at a bat house occupied by a nursery colony of little brown myotis in Pennsylvania. Temperatures in roosting crevices remained in the 80-100°F range for 16 hours a day, falling below 80° only for eight hours in the morning. The house is similar to our nursery design and is vented, covered with black tar paper and exposed to approximately seven hours of full sun each day.

and seasonal cycles, which provides a wider margin for error in selecting appropriate sun exposure and color.

Bats in nursery colonies prefer warm houses, ideally where temperature gradients cover at least a 10° to 15° F range, predominantly between 80° and 100° F, meaning that their roosts require solar heating in all but the hottest climates. The graph in Figure 1 (above) illustrates the impact of solar heating on a black bat house by comparing internal and external temperatures over a 24-hour cycle. This house was occupied by a nursery colony of little brown myotis.

In areas where high temperatures in July average 80° F or less, houses should be black and receive at least 10 hours of daily sun; more may be better. Even in areas where high temperatures in July average less than 100° F, houses of appropriate color should receive at least six hours of direct sun daily.

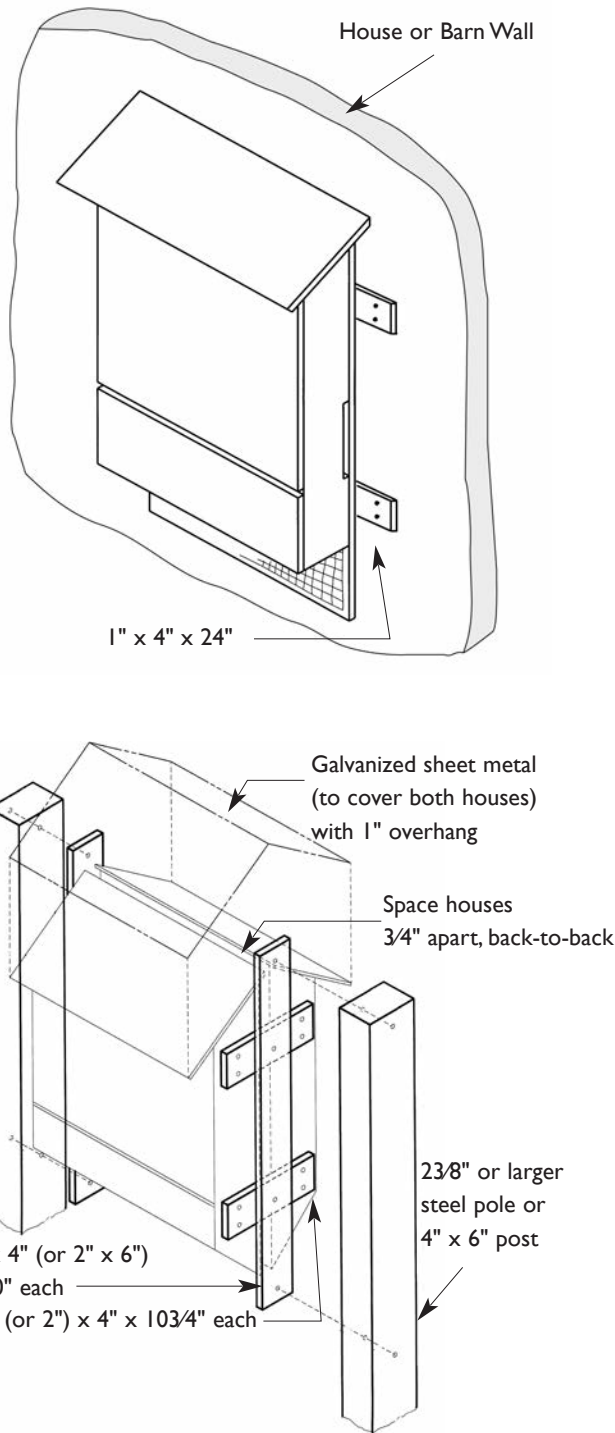

FIGURE 2: Nursery houses can be mounted independently on the side of a building or on a pole. However, when houses are mounted back-to-back in pairs, the space between can accommodate more bats and provide an especially well-ventilated area for use on hot days. The tin roof is optional, but aids greatly in protecting the houses from midday sun and creates extra roosting space.

Some sheltered locations, such as barn lofts (*photo on page 25*) or underneath pole barns or porches, can be used successfully, as long as enough of the heat absorbed by the building's roof reaches the bat house. Under these conditions, bat houses typically must be close to the roof to receive adequate warmth.

When two houses are mounted back-to-back on poles, attached at the sides and covered by a tin roof (*Figure 2*), solar heat gain is reduced at midday, when the risk of overheating is greatest. This provides a wide range of temperatures between the house that's exposed to full sun and the one that is largely shaded by the other, partly because heat transfer is minimized by the ventilated area between them.

By roughening the backs of both houses and providing a 3/4-inch horizontal ventilation slot in the rear of each, another roosting chamber is created with access from either house or the sides. An exceptional temperature range is provided for bats to choose from, with a much-reduced risk of overheating.

In climates where high temperatures in July average 100° F or more, extra protection can be provided by extending the overhang of the metal roof to lengthen the period of midday shade.

Habitat

Most nursery colonies choose roosts within a quarter-mile of permanent fresh water, preferably a stream, pond, river or lake. Greatest bat house success has been achieved in areas of diverse habitat, especially where there is a mixture of agricultural use and natural vegetation (as is often the case around orchards).

Some myotis are most likely to use bat houses located near caves or abandoned mines, where they can hibernate in winter. Big brown bats can hibernate in buildings, cliff-face crevices and other non-cave locations. Many Mexican free-tailed bats migrate south for the winter, although others remain near their summer roosts. Bat houses are also more likely to succeed in areas where bats are frequently found in buildings, particularly where they have been excluded from buildings.

Mounting

Bats find houses mounted on poles or buildings in less than half the time they typically need to find houses mounted on trees. Tree-mounted houses also appear to be less attractive, as they tend to receive less sun and are more vulnerable to predators. Houses mounted under the eaves on wood or stone buildings, but still exposed to the sun, tend to be better protected from rain and predators and have been especially successful.

Nursery colonies of up to 1,100 bats have been attract-

ed to pairs of nursery houses mounted on poles back-to-back, $\frac{3}{4}$ inch apart and covered by a tin roof (*Figure 2*). Buildings offer good mounting sites almost everywhere, but they are essential in very cool or dry climates. In dry areas, where day-to-night temperatures may vary by more than 28° F, buffering from nighttime extremes is needed.

Where climates are moderate to hot with average to high humidity, it is best to test pairs of houses mounted back-to-back on poles – a light one facing north and a moderate to dark one facing south. Houses of different colors can also be tested side by side on buildings, with both houses facing the same direction, in any climate. By observing roost choices of the first occupants, bat preferences can be determined and met by varying the color or sun exposure for subsequent houses.

In intermediate to hot climates, bats typically prefer vented houses, with open bottoms, that provide a wider range of temperatures in a single house. This permits the bats to move vertically to find preferred roosting temperatures as exterior temperatures change.

In the coolest climates, houses can be tested without vents and with all but $\frac{3}{4}$ inch of the sloping bottom covered; this combination increases inside temperature by reducing air circulation.

All bat houses should be caulked and painted or stained to prevent deterioration and leaks. Any leaks that develop must be repaired. Except in extreme southern Florida and the western United States, where larger species may prefer 1- to 1½-inch crevices, $\frac{3}{4}$ -inch crevices seem best.

To the extent possible, locate all houses 20 to 30 feet from tree branches or other obstacles and 12 to 20 feet above ground (or above the tallest vegetation beneath the bat house). Those located nearest an area's largest water source are typically the most successful, as are those in or adjacent to the most diverse or natural vegetation (*Table 1*). The best locations are along streams, rivers, lakes or forests because these are natural bat flyways.

Protection from predators

Safety from predators appears to be a key factor in bats' choice of bat houses. Those mounted on the sides of buildings or high up on poles provide the best protection. The largest colonies attract the most predators and require the greatest height. Locations at least 20 feet from the nearest tree branches or utility wires reduce obstructions and predation and often receive more sunlight.

Where climbing snakes or raccoons occur, you may need to purchase predator guards from a supplier of purple martin birdhouse products. Or you can make your own guards by tightly covering the upper end of a 3-foot section of 10-inch-diameter galvanized stove pipe with

$\frac{1}{4}$ -inch hardware cloth and cutting a hole in the middle for a bat house pole. Place one predator guard around each pole about four feet above the ground. Snakes typically try to climb the inner pole to the screen and give up.

You may further thwart climbing invaders by occasionally oiling the exterior metal. If bats suddenly disappear at a time when they traditionally have been present, the most likely culprits are rat snakes, although other predators can have the same effect.

Avoiding uninvited guests

Houses with open bottoms are far less likely to be occupied by birds, mice, squirrels or parasites, and they do not require removal of accumulated droppings. Wasps do not normally cause problems once bat colonies move into bat houses. Paper wasps, the ones with painful stings, rarely build nests in $\frac{3}{4}$ -inch spaces. If they begin to build a nest at a house entrance, they can be discouraged with blasts of water from a garden hose before their workers emerge. Mud daubers are seldom aggressive and have weak stings. If their nests accumulate inside, just scrape or hose them out when bats are not present.

Cleaning and maintenance

Cleaning open-bottomed houses is unnecessary unless mud dauber or wasp nests accumulate.

Maintenance should not be needed for the first several years for houses that have been carefully caulked and painted before being put up. Recaulking and painting may be necessary eventually, however, and should be done when bats are not present. Drafty houses may be abandoned by bats if not repaired.

Importance of local experiments

We have much to learn about the needs of individual bat species in some areas. Before putting up more than a few houses, you should test for local needs, especially by comparing the occupancy rates of houses with different sun exposures and shades of a color for heat absorption.

To determine the temperature needs of local bats, first try the colors and sun exposures that we recommend. Then try mounting two houses side-by-side on a building where they receive similar sun; paint one darker than the other to see which one the bats prefer. Alternatively, paint one pair of pole-mounted houses darker than another pair, or extend the roof to provide more shade.

When bats move in, observe their behavior to see which house or pair of houses they prefer during temperature extremes through a daily or seasonal cycle. Their choices will provide important clues to their needs, enabling you to enjoy improved success with future houses.

Single-chamber Bat House (wall-mounted)

Materials (makes one house)

- ¼ sheet (2' x 4') ½" AC, BC or T1-11 (outdoor grade) plywood
- One piece 1" x 2" (¾" x 1½" finished) x 8' pine (furring strip)
- 20 to 30 exterior-grade screws, 1"
- One pint dark, water-based stain, exterior grade
- One pint water-based primer, exterior grade
- One quart flat, water-based paint or stain, exterior grade
- One tube paintable latex caulk
- 1" x 4" x 28" board for roof (optional, but highly recommended)
- Black asphalt shingles or galvanized metal (optional)
- 6 to 10 roofing nails, ¾" (if using shingles or metal roofing)

Recommended tools

- | | |
|--------------------------------|----------------------|
| Table saw or handsaw | Caulking gun |
| Variable-speed reversing drill | Paintbrushes |
| Screwdriver bit for drill | Hammer (optional) |
| Tape measure or yardstick | Tin snips (optional) |

Construction

1. Measure and cut plywood into three pieces:
26½" x 24" 16½" x 24" 5" x 24"
2. Roughen inside of backboard and landing area by cutting horizontal grooves with sharp object or saw. Space grooves ¼" to ½" apart, cutting ½" to ⅞" deep.
3. Apply two coats of dark, water-based stain to interior surfaces. Do not use paint, as it will fill grooves.
4. Cut furring strip into one 24" and two 20½" pieces.
5. Attach furring strips to back, caulking first. Start with 24" piece at top. Roost-chamber spacing is ¾".
6. Attach front to furring strips, top piece first (caulk first). Leave ½" vent space between top and bottom front pieces.
7. Caulk all outside joints to further seal roost chamber.
8. Attach a 1" x 4" x 28" board to the top as a roof (optional, but highly recommended).
9. Apply three coats of paint or stain to the exterior (use primer for first coat).
10. Cover roof with shingles or galvanized metal (optional).
11. Mount on building (south or east sides are usually best).

Optional modifications to the single-chamber bat house

1. Wider bat houses can be built for larger colonies. Be sure to adjust dimensions for back and front pieces and ceiling strip. A ¾" support spacer may be needed in the center of the roosting chamber for bat houses over 24" wide to prevent warping.
2. To make a taller version for additional temperature diversity, use these modifications: From a 2' x 8' piece of plywood, cut three pieces: 51" x 24", 33" x 24" and 12" x 24". Cut two 8' furring strips into one 24" and two 44" pieces. Follow assembly procedure above.
3. Ideally, two bat houses can be placed back-to-back, mounted between two poles, to create a three-chamber nursery house. Before assembly, cut a horizontal ¾" slot in the back of each house about 9" from the bottom edge of the back piece to permit movement of bats between houses. Two pieces of wood, 1" x 4" x 4¼", screwed horizontally to each side, will join the two boxes. Leave a ¾" space between the two houses, and roughen the wood surfaces or cover the back of each with plastic mesh (see item 5 below). Do not cover the rear exit slots with mesh. One 1" x 4" x 34" vertical piece, attached to each side over the horizontal pieces, blocks light but allows bats and air to enter. A galvanized metal roof, covering both houses, protects the center roosting area from rain. Eaves should be about 3" in southern areas and about 1½" in the north.
4. Ventilation may not be necessary in cold climates. In this case, the front should be a single piece 23" long. Smaller bat houses like this one will be less successful in cool climates. However, those mounted on buildings maintain thermal stability better and are more likely to attract bats.
5. Durable plastic mesh can be substituted to provide footholds for bats. Attach one 20" x 24½" piece to backboard after staining interior, but prior to assembly. Details on page 11.

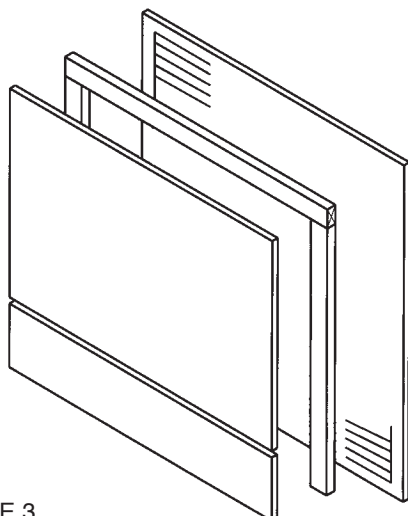
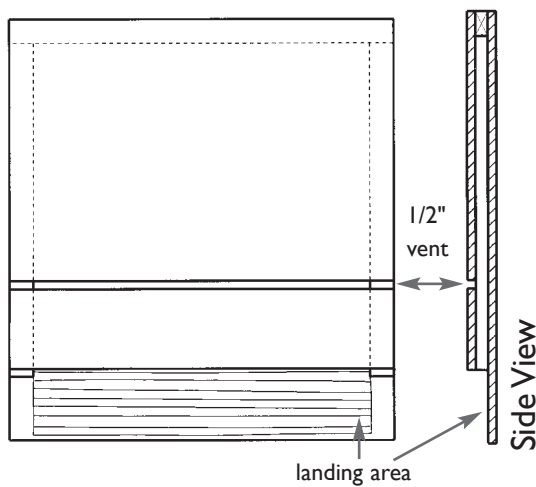

FIGURE 3

Four-chamber Nursery House

Materials (makes two houses) • Diagrams on pages 12 & 13
 ½ sheet (4' x 4') ½" AC, BC or T1-11 (outdoor grade) plywood
 ½ sheet (4' x 4') ¾" AC or BC (outdoor grade) plywood
 Two pieces 1" x 6" (¾" x 5½" finished) x 8' pine or cedar
 One lb. coated deck or exterior-grade screws, 1½"
 20 to 25 coated deck or exterior-grade screws, 1¼"
 20 to 25 exterior-grade screws, 1"
 One quart dark, water-based stain, exterior grade
 One quart water-based primer, exterior grade
 Two quarts flat water-based paint or stain, exterior grade
 One tube paintable latex caulk
 Black asphalt shingles or galvanized metal
 12 to 20 roofing nails, ¾"

Recommended tools

| | |
|--------------------------------|----------------------|
| Table saw or circular saw | Paintbrushes |
| Variable-speed reversing drill | Hammer (optional) |
| Screwdriver bit for drill | Tin snips (optional) |
| Tape measure or yardstick | Bar clamp (optional) |
| Caulking gun | Sander (optional) |

Construction

1. Measure, mark and cut out all wood according to the sawing diagrams on pages 12 and 13.
2. Roughen interior and landing surfaces by cutting horizontal grooves with sharp object or saw. Space grooves ¼" to ½" apart, cutting ½" to ⅙" deep.
3. Apply two coats of dark, water-based stain to interior surfaces. Do not use paint unless the grooves are quite deep.
4. Attach side pieces to back, caulking first. Use 1½" screws. Make sure top angles match.
5. Attach 5" and 10" spacers to inside corners per drawings on page 12. Use 1" screws. Roost-chamber spacing will be ¾" (front to back). Do not block side vents.
6. Place first roosting partition on spacers even with bottom edge of roof. Place 20" spacers on partition and screw to first spacers (through partition), using 1½" screws.
7. Repeat step 6 for remaining spacers and partitions.
8. Attach front to sides, top piece first (caulk seams). Be sure top angles match (sand if necessary). Leave ½" vent space between top and bottom front pieces. A bar clamp may be useful if sides have flared out during construction.
9. Attach roof supports to the top inside of front and back pieces with 1" screws. Don't let screws protrude into roosting chambers.
10. Caulk around all top surfaces, sanding first if necessary to ensure good fit with roof.
11. Attach roof to sides and roof supports with 1¼" screws. Caulk around roof and side joints to further guard against leaks and drafts. Don't let screws protrude into roosting chambers.
12. Paint or stain exterior three times (use primer for first coat).
13. Cover roof with shingles or galvanized metal.

Optional modifications

1. These nursery-house dimensions were chosen to permit construction of two bat houses per half-sheet of plywood. Increasing house width to 24" or more or adding partitions benefits bats and attracts larger colonies. Additional spacers are required to prevent warping of roost partitions for houses more than 24" wide.
2. Taller bat houses provide improved temperature gradients and may be especially useful in climates where daily temperatures fluctuate widely. Bat houses 3' or taller should have the horizontal vent slot 12" from the bottom of the roosting chambers.
3. Two bat houses can be placed back-to-back mounted on poles. Before assembly, a horizontal ¾" slot should be cut in the back of each house about 10" from the bottom edge of the back piece to permit movement of bats between houses. Two pieces of wood, 1" x 4" x 10¾", screwed horizontally to each side, will join the two boxes. Leave a ¾" space between the two houses, and roughen the wood surfaces or cover the back of each with plastic mesh. One 2" x 4" x 40" vertical piece, attached to each side, over the horizontal pieces, blocks light but allows bats and air to enter. Use a 2" x 6" vertical piece if securing houses with U-bolts to metal poles. A galvanized metal roof that covers both houses protects them and helps prevent overheating. Eaves should extend about 3" in front in southern areas and about 1½" in the north.
4. Ventilation may not be necessary in cold climates. In that case, the front of the bat house should be a single, 23"-long piece. Far-northern bat houses may also benefit from a partial bottom to help retain heat. Slope the sides and bottom at an angle of 45° or greater to reduce guano build-up. Leave a ¾" entry gap at the back and be sure the bottom does not interfere with access to the front crevices. A hinged bottom is required to permit annual cleaning.
5. Durable plastic mesh can be substituted for roughening. Attach mesh to backboard, landing area and one side of each partition after staining interior, but prior to assembly. Use only ½-inch HDPE plastic mesh (such as "bat house netting XV1672" from www.industrialnetting.com/bat_houses.html) and attach every two inches with ⅝" stainless steel staples.
6. Make partitions removable by attaching small cleats with thumbscrews to the bottom of side pieces for support. Spacer strips are unnecessary if grooves for partitions are cut in the side pieces with a router or dado saw blade.

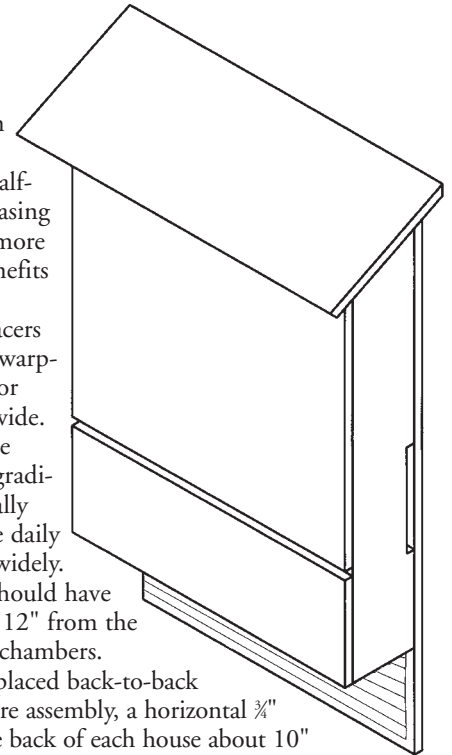
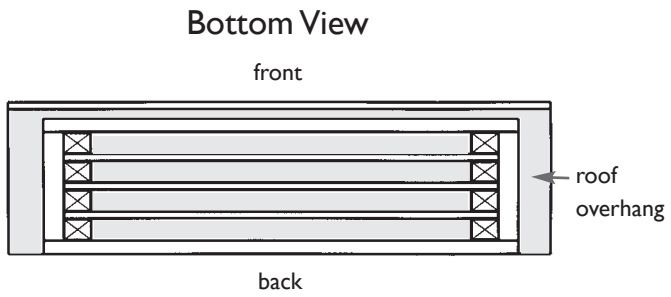
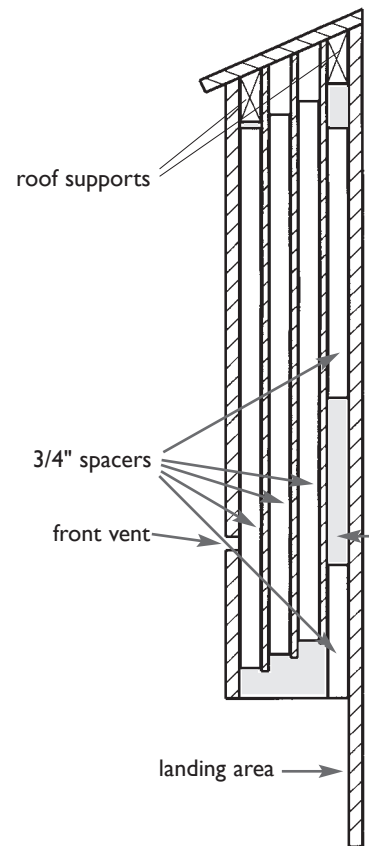
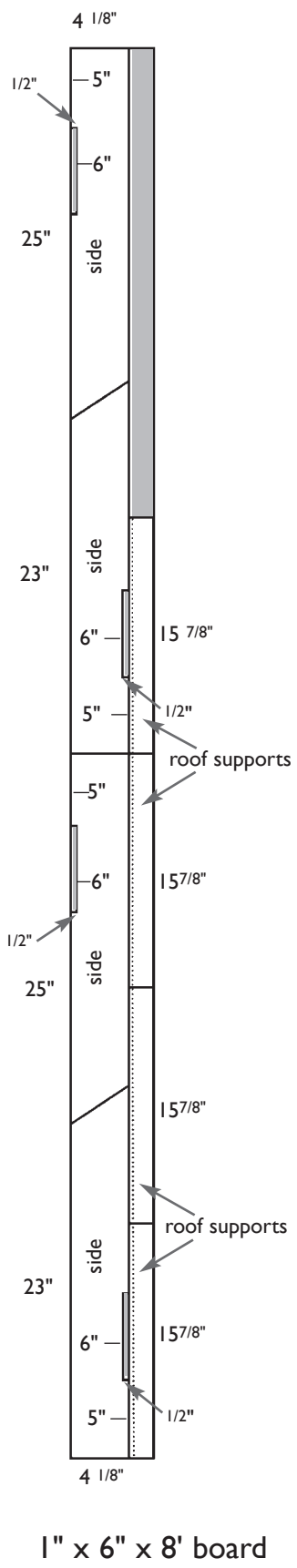
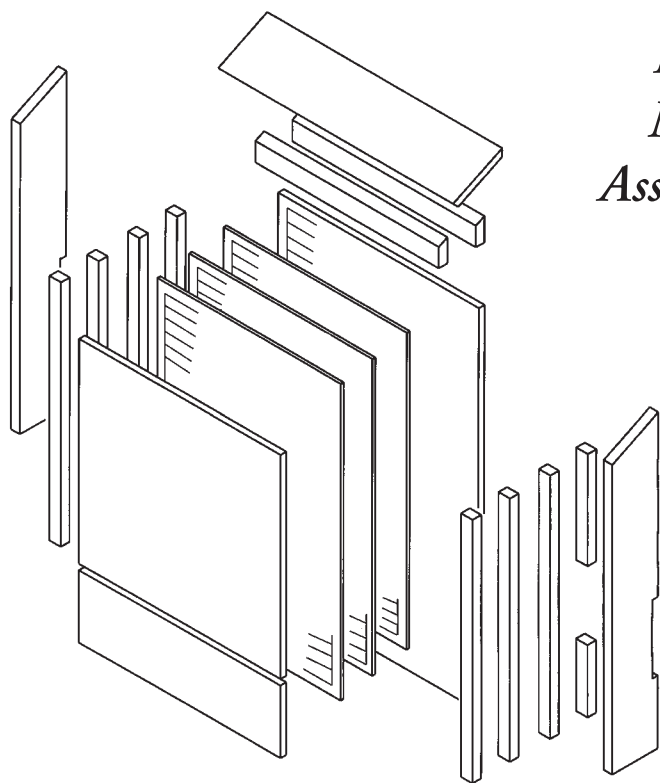

FIGURE 4
*Four-chamber
 Nursery House
 Assembly Diagrams*



1" x 6" x 8' board

FIGURE 5

*Four-chamber
Nursery House
Sawing Diagrams*

■ extra material
 25 degree bevel

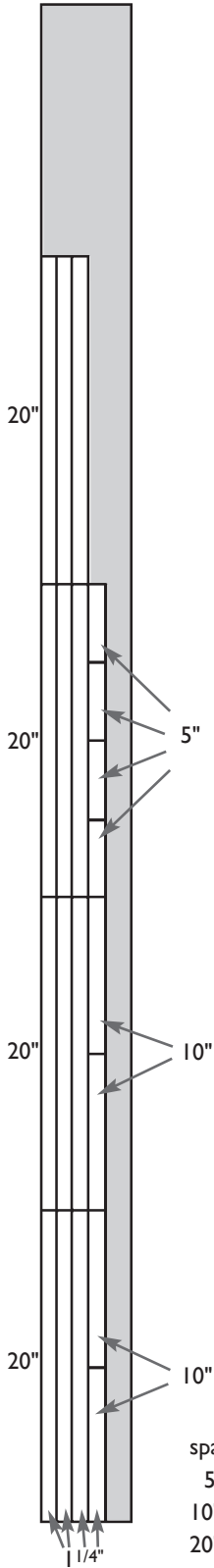

1" x 6" x 8' board

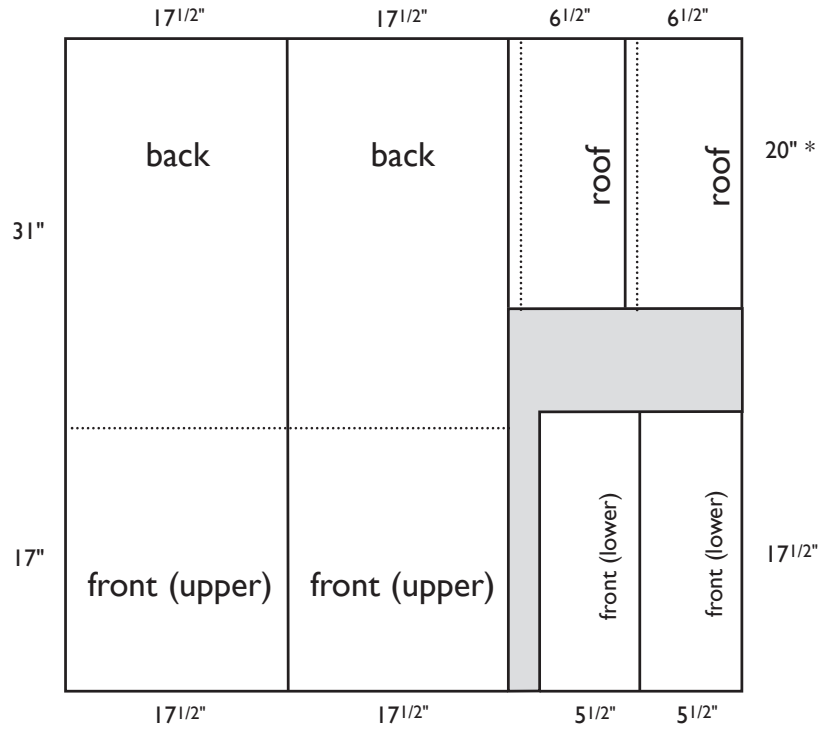

4' x 4' x 1/2" plywood

* 19" if mounted between two poles

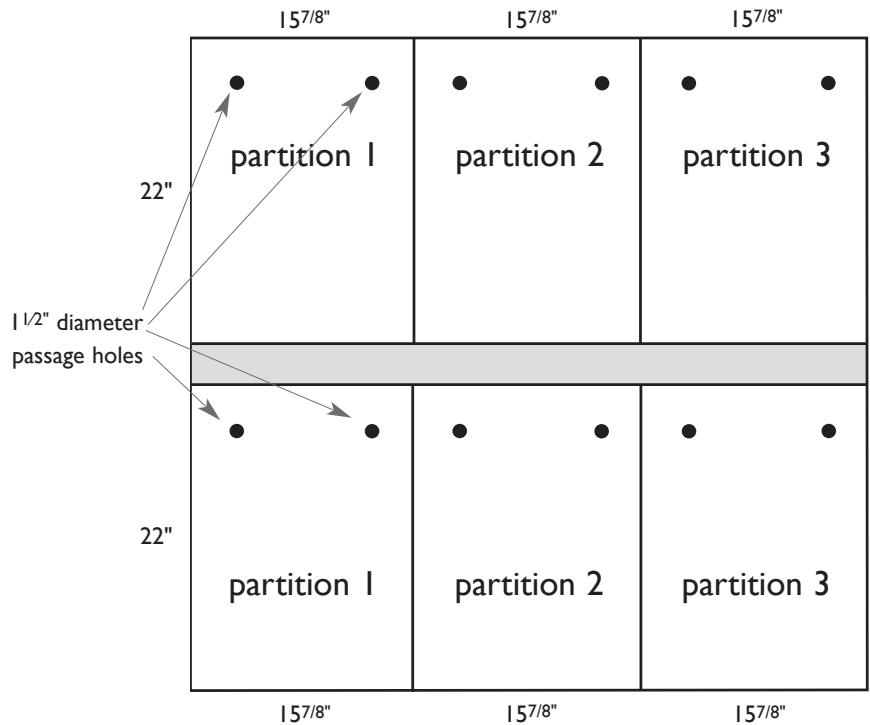

4' x 4' x 3/8" plywood

Two-chamber Rocket Box

Materials (makes one house)

- 2" diameter (2 3/8" outside diameter) steel pole, 20' long
- Two 1" x 4" (3/4" x 3 1/2" finished) x 8' boards*
- Two 1" x 8" (3/4" x 7 1/4" finished) x 8' boards*

- Two 1" x 10" (3/4" x 9 1/4" finished) x 6' boards*
- 24" x 24" x 3/4" piece of AC exterior plywood
- Box of 100 exterior-grade screws, 1 1/8"
- Box of 100 exterior-grade screws, 1 1/4"
- 16 to 32 exterior-grade screws, 2"

* Western red cedar or poplar preferred

- 20 to 30 roofing nails, 7/8"
- One quart water-based primer, exterior grade
- Two quarts flat, water-based stain or paint, exterior grade
- Asphalt shingles or dark galvanized metal
- One tube paintable latex caulk
- Two 1/4" x 4 1/2" carriage bolts, washers and nuts

Recommended tools

- Table saw or circular saw
- Caulk gun
- Hammer
- Tape measure
- Square
- Jigsaw, keyhole saw or router
- Sandpaper or sander
- Rasp or wood file
- Variable-speed reversing drill
- 1 1/2" hole saw or spade bit
- 3/8" and 1/4" drill bits
- Screwdriver bit for drill

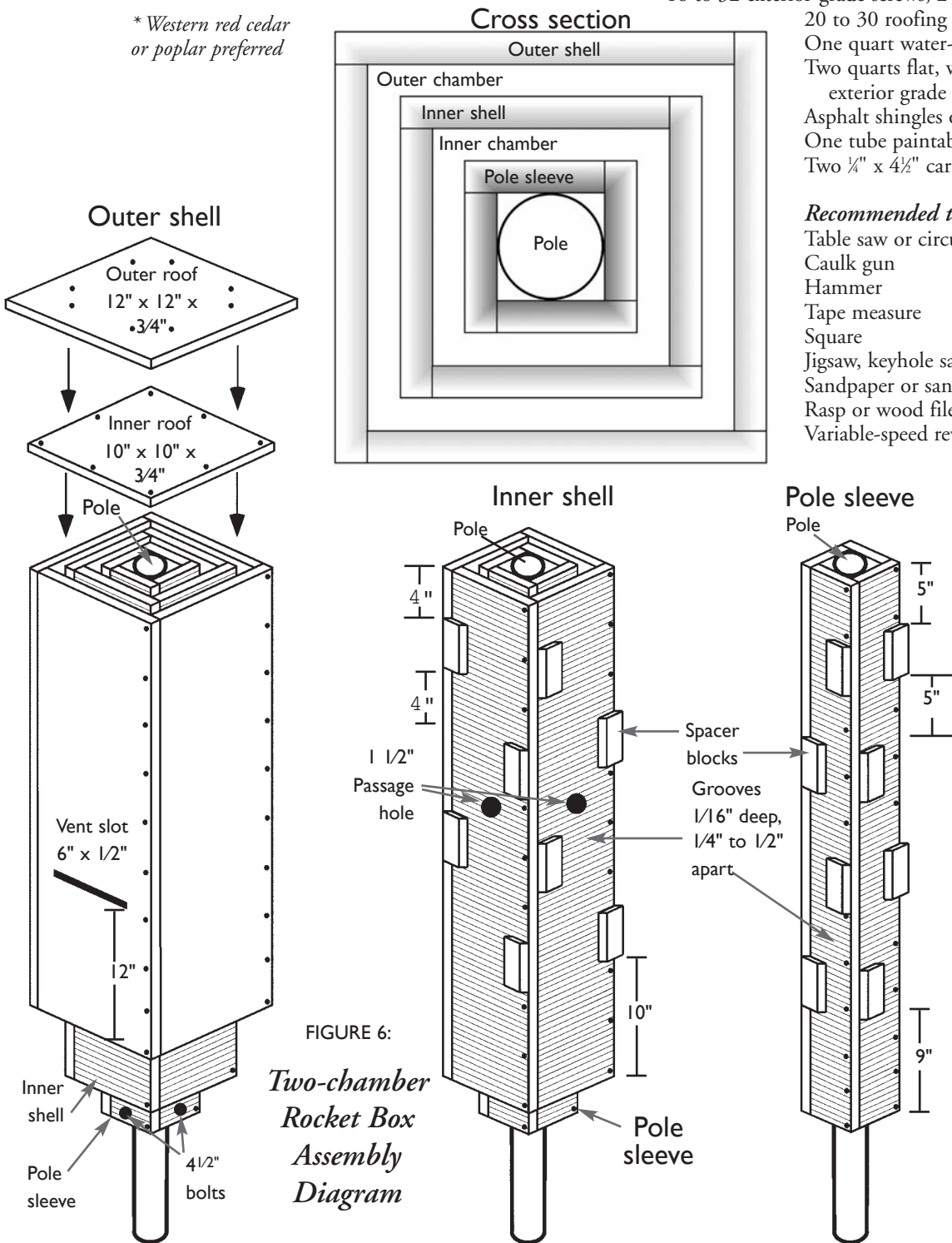

FIGURE 6:
Two-chamber Rocket Box Assembly Diagram

Construction

1. Measure, mark and cut out parts according to Figure 7. Dimensions must be exact for correct fit. Cut out two vent slots and four passage holes as shown.
2. Cut 1/8"-deep horizontal grooves 1/4" to 1/2" apart on one side of all 36" and 45" boards and on both sides of all 42" boards. Sand to remove splinters.
3. Drill two 3/8" holes through each 3/4" x 1 1/2" x 4" spacer block to prevent splitting.
4. Assemble four pole sleeve boards into a hollow, square box as shown using 1 1/8" screws and caulk. Pre-drill holes to prevent splitting. Countersinking holes may also help.

5. Attach spacer blocks to pole sleeve as shown (four per side) using two 1/4" screws per block. Bottom spacer blocks are 9" up from bottom of pole sleeve. Top spacer blocks are 5" from top. Alternate spacer blocks on left and right sides, 5" apart.
6. Assemble four inner shell boards into a hollow, square box as in step 4.
7. Slide pole sleeve into inner shell until top edges are flush. Bat passage holes will be towards the top. Mark location of spacer blocks. Secure inner shell to pole sleeve with 2" screws through the spacer blocks to ensure no screws protrude into roosting chambers. Pre-drill holes first to avoid splitting spacer blocks (countersinking holes may also help).
8. Attach spacer blocks (4 per side) to inner shell as shown, using two 1/4" screws per block. Bottom spacer blocks are 10" up from the bottom edge of the inner shell. Top spacers are 4" from top. Alternate spacers left and right sides, 4" apart.
9. Assemble four outer-shell boards into a hollow, square box as in step 4. Vent slots are on opposing sides and oriented towards the bottom.
10. Slide finished outer shell over inner shell, so that 6" of inner shell protrudes below outer shell. Mark locations of spacer blocks. Secure outer shell to inner shell as in step 7 (pre-drill holes first). Ensure that no screws protrude into the roosting chambers.
11. Caulking first, attach inner roof to box with 1/4" screws. Carefully drive screws into top edges of shells to prevent screws from entering roosting chambers.
12. Center and attach outer roof to inner roof with 1/4" screws, caulking first.
13. Paint or stain exterior three times (use primer for first coat). Cover roof with shingles or dark galvanized metal.
14. Slide completed rocket box over pole. One inch up from the bottom edge of pole sleeve, drill a 1/4" hole all the way through pole and sleeve. Rotate box and pole 90° and drill another 1/4" hole, 2 inches from the bottom, through pole and sleeve. Secure box to pole with two 4 1/2" bolts, washers and nuts. Orient vent slots north and south during installation.

Optional modifications to the rocket box

1. For extra mounting height, insert a 4 1/2" bolt and nut about halfway up through pole sleeve after completing step 5.
2. For extra heat-holding capacity, create a compartment in upper half of pole sleeve with a 2 1/2"-square piece of leftover plywood. Fill upper half of sleeve with sand, gravel or dirt, and seal with another piece of plywood flush with top.
3. In warmer climates, a larger outer roof with more overhang can be used for additional shading.

2' x 2' x 3/4" AC plywood

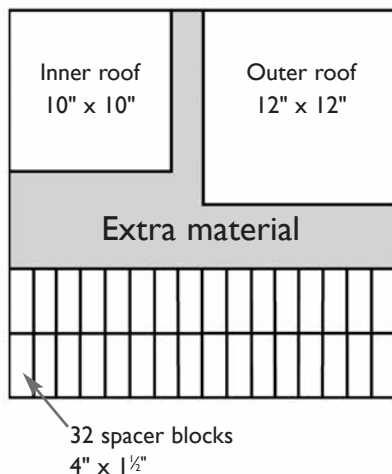
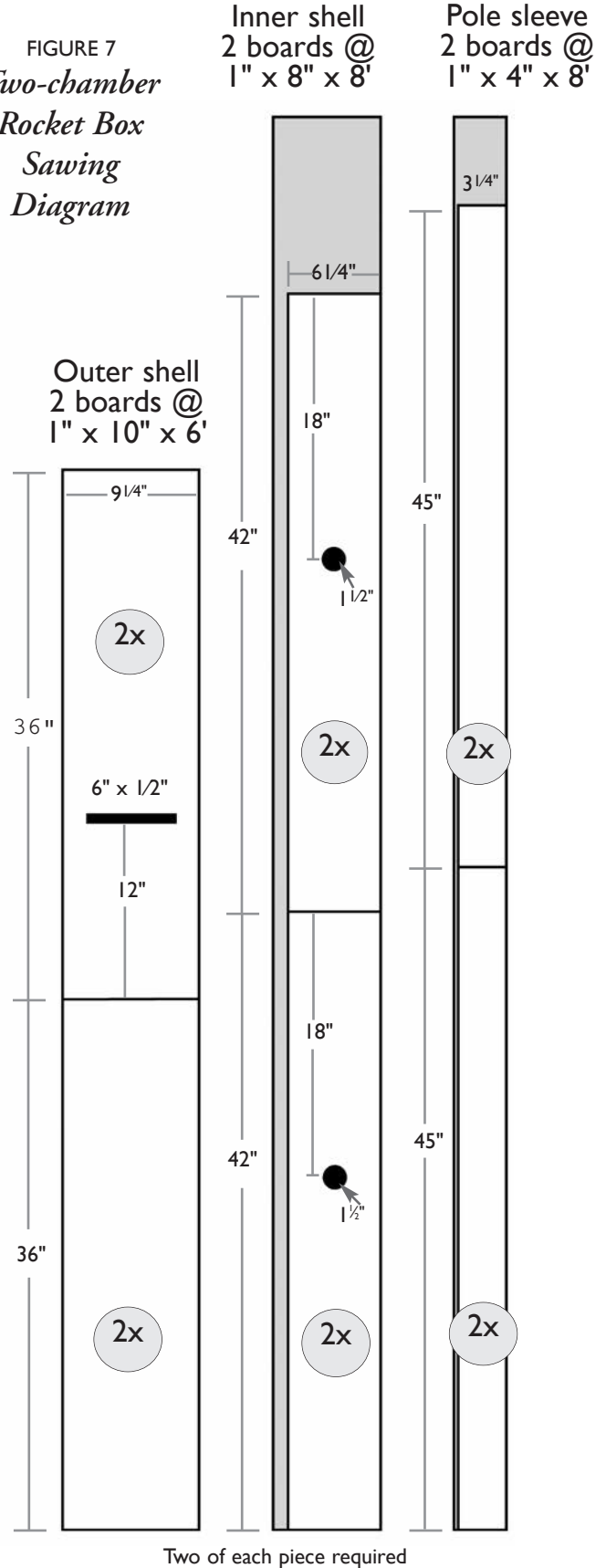

FIGURE 7
Two-chamber Rocket Box Sawing Diagram



Pointers for Bat House Experimenters

SUNNY SANDERS WAITED five years for bats to move into the bat house she placed on the shaded side of her home. They never showed up. Then, following advice from BCI, she moved the bat house to the sunnier east end of her home. More than 300 Mexican free-tailed bats moved in within weeks.

A little experimenting can make a world of difference.

As we noted earlier, bat house success is enhanced dramatically when houses are:

- caulked and painted to be airtight and watertight;
- colored and hung to meet local needs for solar heating;
- mounted 12 to 20 feet or higher on buildings or on poles at least 20 feet from the nearest obstacle;
- located near rivers, lakes or ponds, especially along

water or forest edges or where varied agriculture is mixed with natural habitat.

Even with BCI-certified bat houses or those built from our plans, you should conduct local experiments before putting up a large number of bat houses or extra-large houses in any new area.

Bat houses that are mounted on buildings, like these being installed on the side of a California barn, typically perform best in Bat House Project surveys, especially in hot, dry climates.

Attention to seemingly small details can make a big difference in bat house success ...

Temperature is always a critical consideration. Initial tests can be accomplished by:

1) mounting houses in pairs on buildings, one darker, the other lighter;

2) varying the amount or timing of exposure to heat from the sun;

3) comparing back-to-back, pole-mounted pairs of houses with darker and lighter shades of a color or with longer and shorter roof overhangs;

4) orienting pairs of houses on poles with one facing north and the other south to vary temperature ranges.

Successful bat houses usually attract their first bats during the summer after installation, so houses put up in fall or winter are likely to sit empty until the following summer. Nursery colonies often begin with just one or a few individuals in the first season, then expand their numbers over the next several years.

Annual use cycles may range from a few weeks to entire summers in cool climates. In warmer southern areas, such as Florida and Texas, bats may use houses from February to November or even year-round. In more northern climates, bats probably will begin arriving in April or May, sometimes not until early June, and may depart anytime from July to October.

Use patterns are typically repeated from year to year. Sometimes, annual use periods can be greatly extended by providing better temperature ranges, with several warmer or cooler houses placed in the same general vicinity.

To test your local bats' roost preferences, you need to observe them. This is simple if you just shine a bright light up into the open bottoms. For very high houses, you may need to have someone shine a light while you look with binoculars. Make observations as brief as possible at first to avoid disturbing the bats.

Once a colony is established, bats are usually quite tolerant of people looking at them as long as you don't touch the mounting poles or houses and don't use bright lights for more than 10 seconds at a time.

Counting just a few bats may involve nothing more than looking inside the bat house. But for larger colonies, the only reasonably accurate method is to count them as they emerge at dusk to feed on insects.

To determine if you have a nursery colony, briefly look inside after the adults emerge. Pups are always left behind at night for three to six weeks after birth, until they learn



MARK & SELENA KISER, BCI / 9166203

Bat House Color Recommendations and Average Daily High Temperatures in July

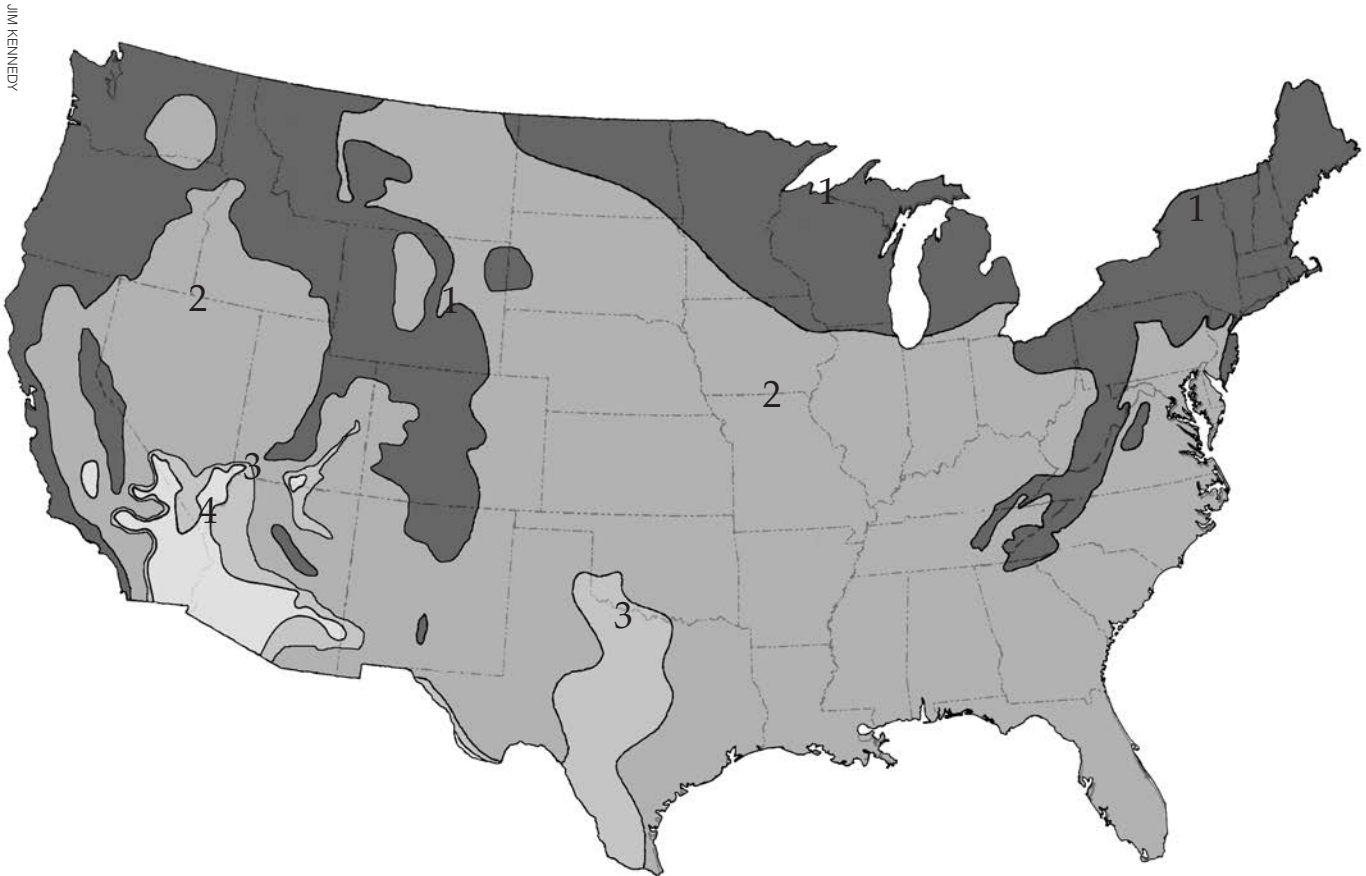

1. Dark areas: less than 85° F. – Black or dark shade of paint.

2. Medium areas: 85°-95° F. – Dark or medium shade of paint.

3. Light areas: 95°-100° F. – Medium or light shade of paint.

4. Lightest areas: 100° F or greater. – White or light shade of paint.

to fly. Mothers usually give birth as early as April or May in the warmer areas and as late as July in the coolest.

Testing bat needs is relatively easy once even a few bats move into one of your houses. Simply provide other, nearby houses that offer more or less sun, darker or lighter colors, improved landing areas or rougher climbing surfaces, paired houses with greater temperature ranges, etc.

Careful observations of daily and seasonal movements within and between houses during both cool and hot periods can provide vital knowledge about how best to help your local bats. And by sharing that information, you can contribute greatly to progress.

FIGURE 8

Years of research have shown that bat houses are far more successful at attracting bats if they are painted or stained. Painting helps provide the proper internal temperature for bats and also increases the life span of the bat house. Appropriate color depends upon geographic location and amount of sun exposure. At least six hours of direct daily sun are recommended for all bat houses where daily high temperatures in July average less than 100° F. Houses where high temperatures in July average 80° F or less should receive as much sunlight as possible. Adjust to darker colors for less sun. Use exterior-quality, water-based stain or latex paint, and choose flat paint rather than gloss or semi-gloss paint for best solar absorption.

BCI Research Boosts Bat House Success

BAT CONSERVATION INTERNATIONAL'S BAT HOUSE PROJECT has revolutionized our ability to help bats in need of homes. For more than a decade, 7,000 Research Associate volunteers and colleagues have collected and shared data from bat houses in varied climates and habitats across the continent. These findings have dramatically increased bat house success. Today, at least 16 of 47 North American bat species are using bat houses and other artificial roosts that shelter hundreds of thousands of bats.

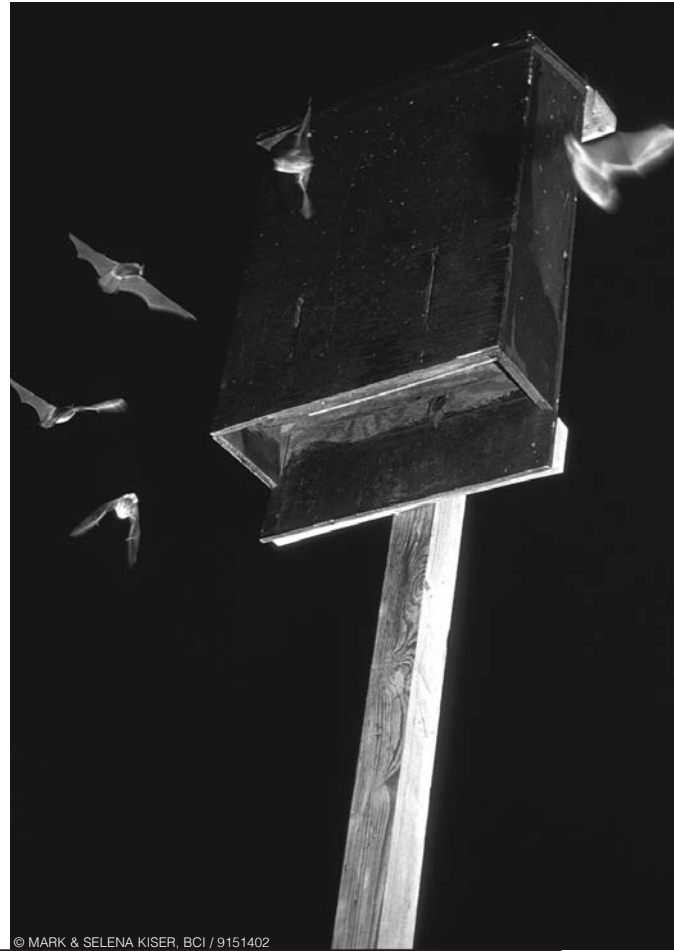

Factors Influencing Bat House Use

Combined Bat House Project annual surveys (1998-2001)

© MARK & SELENA KISER, BCI / 9151402

| Occupancy Rate | | Number of Houses | | Occupancy Rate | | Number of Houses | |
|---|-----|------------------|------------------------------------|--|------------|------------------|--|
| Mounting Location | | | | Dominant Land Use Within 1-mile radius | | | |
| Trees | 20% | 25 of 125 | Cattle Ranching | 48% | 32 of 66 | | |
| Poles | 52% | 503 of 960 | Residential | 48% | 146 of 306 | | |
| Wooden/Masonry Buildings | 64% | 264 of 411 | Farms/Natural Vegetation | 57% | 272 of 474 | | |
| | | | Natural Vegetation | 59% | 304 of 519 | | |
| Roost Chamber Height | | | | Dominant Farm Type Within 1-mile radius | | | |
| Less than 15" | 44% | 98 of 222 | Row Crops | 24% | 18 of 76 | | |
| 15 to 24" | 51% | 485 of 957 | Pastures/Row Crops | 52% | 156 of 298 | | |
| 25" or more | 64% | 239 of 374 | Pastures | 53% | 140 of 265 | | |
| | | | Orchards | 67% | 37 of 55 | | |
| Roost Chamber Width (side to side) | | | | Pastures/Row Crops/Orchards | | | |
| Less than 15" | 51% | 179 of 348 | | 68% | 103 of 152 | | |
| 15 to 24" | 55% | 385 of 698 | Dominant Natural Vegetation | | | | |
| 25" or more | 72% | 84 of 117 | Wetland | 28% | 19 of 67 | | |
| | | | Desert | 31% | 25 of 80 | | |
| Number of Chambers | | | | Forest | 54% | 409 of 753 | |
| 1 or 2 | 50% | 243 of 490 | Grassland | 55% | 142 of 259 | | |
| 3 or 4 | 50% | 386 of 768 | Overgrown Field/Shrub | 61% | 132 of 217 | | |
| 5 or more | 65% | 193 of 295 | Nearest Freshwater Source | | | | |
| | | | Marsh (all sizes) | 38% | 32 of 85 | | |
| Urbanization | | | | Stream (less than 50' wide) | 50% | 229 of 454 | |
| Urban | 41% | 46 of 112 | Pond (less than 25 acres) | 51% | 234 of 463 | | |
| Suburban | 42% | 112 of 267 | River (greater than 50' wide) | 60% | 110 of 184 | | |
| Rural | 57% | 664 of 1,174 | Lake (greater than 25 acres) | 61% | 190 of 313 | | |

TABLE I

Historical perspective

SINCE BAT CONSERVATION INTERNATIONAL FIRST popularized bat houses in the early 1980s, thousands have been erected in backyards, parks and forests all across North America. Yet few things in the history of bat conservation have generated more controversy. Claims and counterclaims over whether bat houses work have too often been based only on limited local observations. As a result, many erroneous conclusions have been made and publicized about the effectiveness of bat houses.

We now know a great deal more, thanks to the many BCI members and Research Associates who tested and reported bat house use under a wide variety of conditions and geographical locations. And the more we learn, the more effective bat houses become.

BCI conducted its first comprehensive bat house survey in 1992. Four hundred and twenty people with bat houses in 26 U.S. states and one Canadian province participated. The results included many surprises and led to a wide range of experiments on bat house use, design and location. But the most encouraging news in that first study was how successful bat houses already were: 52% of the houses attracted bats. (These early pioneers were, of course, serious experimenters whose bat houses often had been in place for several years.)

A short time later, we began conducting annual bat house surveys with our tireless Research Associates to learn more about what does and does not work. Research Associates systematically collected data about their bat houses and sent the information to us for analysis and for sharing with bat house landlords everywhere.

By 2000, 61% of all surveyed bat houses (in a great variety of locations) were successful. And success rates can

exceed 90% for bat houses that meet the critical criteria gleaned from more than a decade of surveys.

We used data gathered that first year, for instance, to examine occupancy rates for houses in the northern United States that met just two important criteria: houses that received four or more hours of daily sunlight and were located a quarter mile or less from a stream, river or lake larger than three acres. Those houses registered an occupancy rate of 83%. When we added a third factor – houses stained or painted a dark color – occupancy rose to 92%.

After years of collaborative research, we have clearly documented the key requirements for successful bat houses. We also used that knowledge to develop a basic bat house design that has proven very useful for the majority of America's most widespread species of crevice-dwelling bats. These species, the main focus of our bat house research thus far, prefer to roost in $\frac{3}{4}$ -inch crevices.

The basic design, adapted to a number of variations, does not require species-specific knowledge and enables countless novice bat fanciers, farmers and wildlife managers to install successful bat houses. The bat house plans in this book reflect this proven design.

Early days

In the 1980s, bat houses were usually small, unpainted, uncaulked and mounted in shaded locations on trees, often with roost chambers more than an inch wide. Then BCI's first bat house survey revealed that most bats prefer painted houses with $\frac{3}{4}$ -inch roosting chambers, especially when such houses are mounted in full sun on buildings and poles. These findings led to publication of the original edi-



© MARK & SELENA KISER, BCI | 9151408

Little brown myotis pack the crevices of this bat house in Pennsylvania. Bat house enthusiasts who follow the guidelines developed over the past decade by the North American Bat House Research Project dramatically improve their chances of success.

The Impact of Bat House Design

| Design (Linear Roost Space*) | Maternity Use | Number of Houses Occupied and Total Surveyed | Occupancy Rate |
|------------------------------|---------------|--|----------------|
| Small/Single Chamber (<2.5') | 13% | 96 of 269 | 36% |
| Medium (2.5' to 15') | 28% | 548 of 1,018 | 54% |
| Large (15' to 50') | 44% | 45 of 77 | 58% |

*Linear roost space = total length (side to side) of all roost chambers combined

TABLE 2

tion of *The Bat House Builder's Handbook*, which identified important areas for further research. The results presented here cover 1,553 bat houses reported from 1998 to 2001.

Fully understanding bats' roosting needs requires comparing countless observations of many species living in diverse climates and habitats – an impossible task without the help of many dedicated volunteers across the continent. BCI's founding of the North American Bat House Research Project (later the Bat House Project) in 1992 enabled continentwide sharing of consistent data.

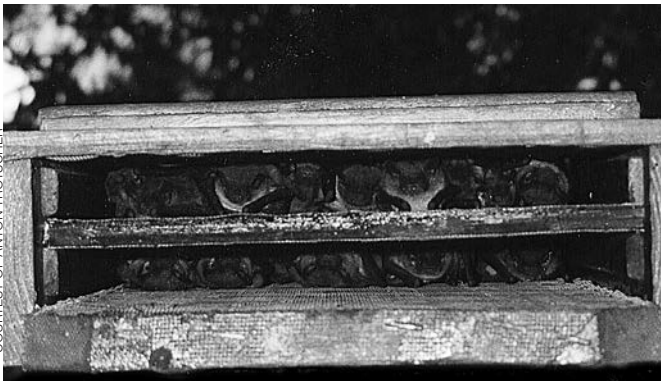

COURTESY OF ANTON TROTSCHER

Even in big cities, bat houses can be quite successful. Big brown bats find shelter in this suburban, backyard bat house barely a third of a mile from a busy interstate highway in Houston, Texas.

Success stories

Frank and Teresa Bibin joined the North American Bat House Research Project in 1996, shortly after they decided to “go organic” with their 27-acre pecan orchard in Georgia. They put up their first bat house that July, hoping that insect-eating bats might ease the heavy damage their crops were suffering from the larvae of hickory shuckworm moths. Though they had seen few bats on the property, the site – an agricultural spread surrounded by woodlands with nearby creeks and ponds – seemed ideal.

Bats began arriving in March 1998 and more than 100 of them spent the summer eating shuckworm moths and other insects among the pecan trees. Over the years, the

Bibins added more houses, experimenting to determine the most favored colors, solar exposure and orientation. Now the Bibins have 13 bat houses, as many as 3,000 bats and, they report, virtually no crop losses due to shuckworms.

That is the kind of success that's possible when BCI recommendations are combined with on-site experimentation to meet the needs of bats.

Farther north, Pennsylvania wildlife biologist Cal Butchkoski offers a similar role model. He built his initial bat house out of an old army-surplus ammo box in 1989 and was host to a colony of little brown myotis within months. Since then, he's built and installed more than 70 bat houses and monitors dozens more. The occupancy rate for Butchkoski's bat houses is 91 percent.

His secrets for success: attention to detail, continuing observation of bats' needs in varied habitats and, always, a willingness to change based on observations and experience.

Some basic lessons

Though a wide range of bat house sizes and styles are still being used, we consistently find that bats prefer larger houses and those mounted on buildings or other large wooden or concrete structures (*Tables 1 and 2*). Both preferences help buffer day-to-night temperature fluctuations, which appear to be a dominant concern for roosting bats, especially nursery colonies.

For bat houses mounted on buildings, those with chambers at least 20 inches wide (side to side) were inhabited 82% of the time (83 of 101 houses); houses of the same width and with chambers at least 25 inches tall achieved 90% occupancy (37 of 41 houses).

Local testing remains a key element in success. Our findings suggest that the best approach is to begin by testing two or three – usually not more than six – bat houses until the first bats move into the designs and locations they prefer.

Temperature preferences

Aside from basic shelter against the elements and predators, all roosts must maintain appropriate temperatures for a given species. Most colonial bat house tenants seek daytime temperatures of 80° to 100° F for rearing young,

Mexican free-tailed bats are the most common bat house occupants in the South. They like to roost as high as possible aboveground, though houses at heights of 12 to 15 feet have been quite successful.

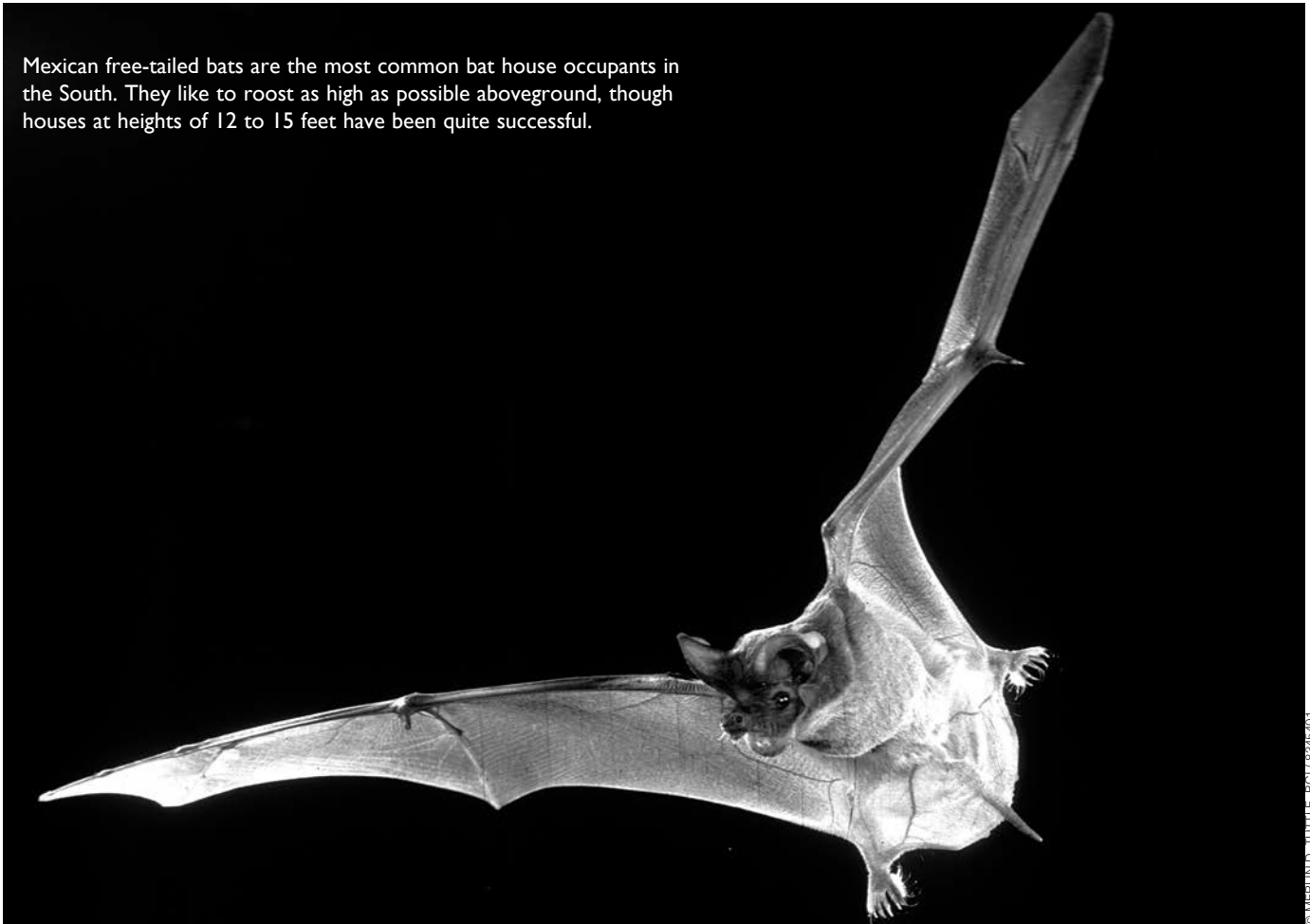

© MERLIN D. TUTTLE-BC178346401

although some tolerate even higher temperatures. In very cold climates, testing should begin with black, unvented houses, mostly placed in the sunniest locations. In very hot areas, the opposite applies, though houses should rarely receive less than six hours of daily sun exposure anywhere. In

most intermediate climates, it's

best to test dark colors versus medium or light colors, often side by side.

A little variety

Erecting multiple houses is an excellent strategy, especially after local preferences have been determined. During periods of extreme weather, bats may need houses that are substan-

tially cooler or warmer than those they normally prefer. Bats may also switch roosts to escape parasites, while some routinely move back and forth among a series of roosts, apparently as a predator-avoidance strategy. More room also means more space for a colony to expand. Options include offering different designs, exterior colors and hours of direct sun exposure.

Our combined surveys show that when three or more houses were installed in a group, 80% were successful (197 of 245 houses). Single houses succeeded only 49% of the time (321 of 657 houses). Multiple houses are especially important when they are relatively small.

When large colonies are to be evicted from buildings, multiple or larger houses increase the odds that displaced bats will find adequate space. Varying placement to obtain more or less solar heating also helps.

Time until first occupancy is reported in Table 3. Most of the occupied houses attracted bats within the first year (average: nine months), while 89 percent were used within two years. One bat house was not inhabited until 13 years, 2 months after installation.

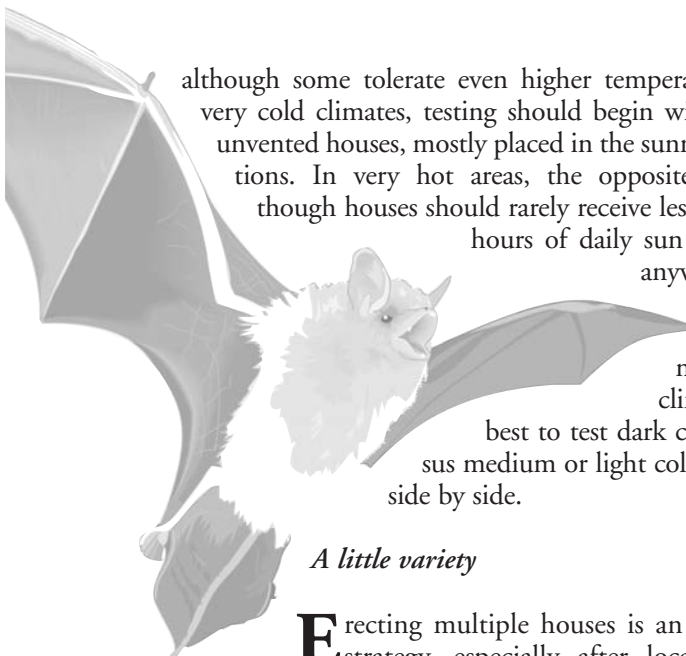

Key features for all bat houses should include roost chambers at least 20 inches tall, caulked or sealed joints, well-painted or stained exteriors and rough-surface roosting and landing areas ...



Above: Painting bat houses extends their longevity and helps promote suitable temperature ranges for bats.
Below: These back-to-back nursery houses in Louisiana are painted different colors to provide a range of temperatures from which bats can choose.



Key features

Bat house designs and materials continue to evolve, but key features for all bat houses should include roost chambers at least 20 inches tall, caulked or sealed joints, well-painted or stained exteriors, rough-surface roosting and landing areas and ventilation slots (except in cold cli-

Time Until First Occupancy

(735 occupied houses. Average: 9 months; range: 0 to 158 months.)

| Time | Percentage of Occupied Houses | Number of Houses |
|-----------------|-------------------------------|------------------|
| <1 month | 13% | 98 |
| 1 to 6 months | 48% | 354 |
| 7 to 12 months | 15% | 111 |
| 13 to 24 months | 13% | 92 |
| 25 to 36 months | 5% | 36 |
| 37 to 48 months | 3% | 22 |
| >48 months | 3% | 22 |

TABLE 3

mates). The more chambers and the taller and wider (side to side) those chambers are, the better.

The “standard” models that fared best in our surveys were nursery and rocket houses. Nursery houses – characterized by tall, multiple chambers, as opposed to a single roosting space – were used for rearing young twice as often as single-chamber houses.

Rocket boxes were 6% more successful in attracting bats than nursery models, but 8% less likely to support nursery use. The high overall use of rocket boxes appears to stem from the increased temperature range available to occupants as they move between sunny and shaded sides along an extra-long vertical axis.

Nursery houses, with their large surface area, provide greater exposure for solar heating, while their multiple chambers reduce the odds of overheating young bats. The largest houses, with 15 to 50 feet of linear roosting crevices, had the highest overall maternity use. While not everyone can build or erect such houses, adding height, width and additional roosting chambers appears to increase the odds of nursery use for any style of house.



Bat preferences are determined through controlled testing. All aspects of the test houses are identical except the attribute being tested. These differently colored houses will test local temperature preferences.

Frequent tenants

The species most commonly reported in North American bat houses are the little brown myotis (*Myotis lucifugus*), Mexican free-tailed bat (*Tadarida brasiliensis*) and big brown bat (*Eptesicus fuscus*). No matter where you live in the lower 48 states and much of Alaska

and Canada, you have the chance to attract at least one of these species, all of which differ in their habitat and water preferences (*Table 4 below*). For example, free-tailed bats occupied houses farther from water, were less associated with forests and occurred more often in urban and suburban areas.

Differences Among Three Most Common Bat House Species

(Bat house occupancy by species according to geographical/land-use variables)

| | | | | | |
|--------------------------------------|--------------------|------------------------------|--------------------------|--------|----------------------------|
| Urbanization | Rural | Suburban | Urban | | |
| Little brown myotis (175 houses) | 91% | 8% | 1% | | |
| Big brown bat (104 houses) | 83% | 9% | 8% | | |
| Mexican free-tailed bat (122 houses) | 58% | 21% | 21% | | |
| Dominant Land Use | Residential | Farms/ Natural Vegetation | Natural Vegetation | Other | |
| Little brown myotis (175 houses) | 5% | 38% | 54% | 3% | |
| Big brown bat (104 houses) | 19% | 15% | 51% | 15% | |
| Mexican free-tailed bat (122 houses) | 44% | 34% | 15% | 7% | |
| Distance to Water | Less than 1/4 mile | 1/4 to 1 mile | More than 1 mile | | |
| Little brown myotis (175 houses) | 93% | 6% | 1% | | |
| Big brown bat (104 houses) | 84% | 16% | 0% | | |
| Mexican free-tailed bat (122 houses) | 66% | 13% | 21% | | |
| Dominant Natural Vegetation | Desert | Grassland | Overgrown Field/Shrub | Forest | Other Vegetation/ Mixed |
| Little brown bat (175 houses) | 0% | 12% | 14% | 74% | 0% |
| Big brown bat (104 houses) | 0% | 27% | 26% | 42% | 5% |
| Mexican free-tailed bat (122 houses) | 11% | 29% | 12% | 20% | 28% |

TABLE 4

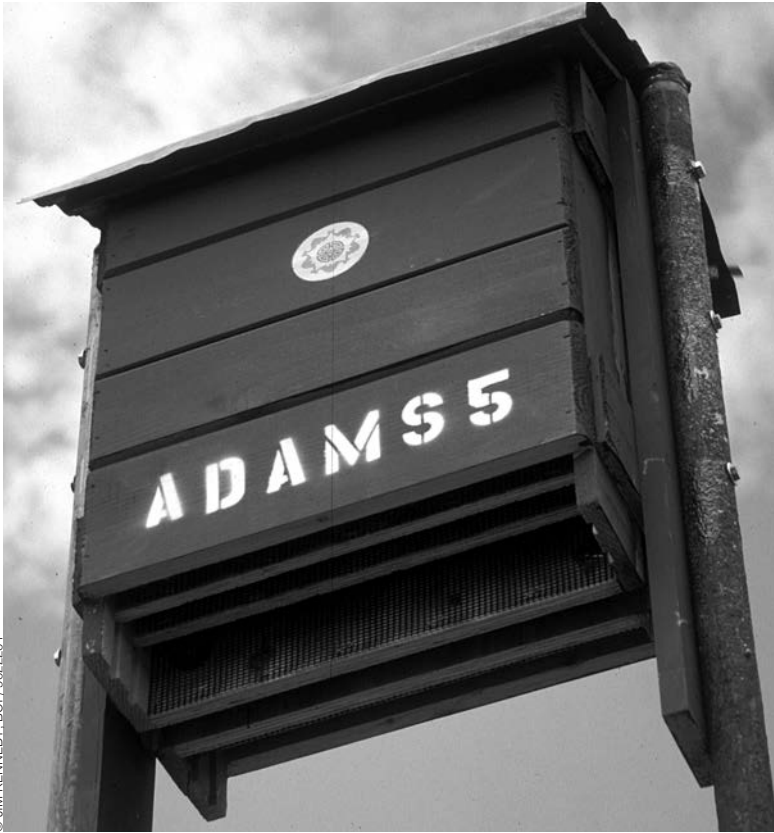

© JIM KENNEDY, BCI / 9022201



© JIM KENNEDY, BCI / 9022310

For More Information

Our knowledge about bats and bat houses never stands still. Bat Conservation International and our colleagues around the world continually conduct studies and experiments to expand our understanding.

You'll find the latest information on bat houses at BCI's bat house webpage:

www.batcon.org/bathouse.

The site provides detailed information on building and installing bat houses, as well as data on custom and community bat houses.

If you are interested in buying a bat house, rather than building it, we offer a current list of vendors whose bat houses have been examined and certified by Bat Conservation International. These "Bat Approved" houses meet BCI's criteria for appropriate design and manufacture.



Vendors will also find instructions for submitting their houses for review and possible certification.

The Resources section of the website offers an assortment of detailed information on many aspects of bat house construction, installation and troubleshooting. These documents may be downloaded without charge.

And while you're online, be sure to explore the rest of BCI's website for a wealth of information of bats, bat research and bat conservation throughout the world.

www.batcon.org

Two bat houses mounted back-to-back with an additional roosting chamber in between create space for more than 500 bats. The brown color, vent slots and north-south orientation provide a maximum temperature gradient. The houses are mounted 15 feet high on poles to protect the bats from climbing predators. The location – near water and in an area of known bat activity – greatly enhances success. (Note that the tongue-and-groove lumber used on these occupied houses gives them the appearance of having more vents.)



© MERLIN D. TUTTLE, BCI / 8766501

What We've Learned from Experimentation

MOST BAT HOUSES IN OUR SURVEYS were purchased from BCI or patterned after BCI designs, but innovative bat house owners have, over the years, experimented with a variety of modifications that have improved our ability to attract larger colonies.

The fact that bat houses only 24 inches tall and wide and 5 or 6 inches deep attracted nursery colonies of as many as 200 to 300 bats was welcome news in 1992. But larger houses capable of sheltering up to several thousand bats have been developed since we began our surveys and have proven especially useful when large colonies must be excluded from buildings.

Expanding nursery-house width (*as in Figures 4 and 5 on pages 12-13*) to 48 inches and pairing such houses back-to-back between two poles can provide shelter for up to 1,800 bats. Extra-large houses, designed for thousands of bats, should not be installed without first testing bat needs by using easier-to-build houses.

Another innovation since the first study is the pole-mounted rocket box, first tested in the mid-1990s by former U.S. Forest Service biologists Dan Dourson and John MacGregor. This design typically consists of one or two simple shells that fit over square, untreated wooden posts. The continuous chambers permit bats to move from sunny to shaded sides to find optimum temperatures. Plastic versions made from round PVC pipe sections (attached to steel poles) and coated with stucco inside and out have also proven successful. In BCI's 1998-2001 combined annual surveys, rocket boxes had a slightly higher occupancy rate than nursery houses, but held fewer bats

Top left: Tony Koch put up nine special bat houses in the loft of his barn to create a more hospitable environment for nursing mother bats. These unusual houses have open sides because of the warmth of the loft. Mother bats routinely move their pups from house to house, perhaps to escape parasites.

Left: In bat houses where the species could be positively identified, the little brown myotis was the most common.



© MERLIN D. TUTTLE, BCI / 8281113



© MERLIN D. TUTTLE, BCI / 0001109

Pallid bats were among those found in bat houses in the Southwest. Although bat houses in lowland desert regions may become too hot for most bats, those placed against shaded buildings, especially stone, have had some success.

on average and had a lower incidence of maternity use.

Many experiments with new construction materials suggest great promise in expanding bat house life spans and increasing their heat-holding capacity.

Insulated houses made with thin outer shells of plastic or galvanized steel coated with stucco were used by colonies of 300 to 500 big brown bats and Mexican free-tailed bats in Texas and California. Bat houses made from such materials as recycled plastic deck lumber and fiber-cement board have also attracted bats.

Experimental plastic rocket boxes with outer chambers that hold 12 pounds of dry sand (to stabilize temperatures) were occupied by three species in Washington, Wisconsin and Texas.

Research consistently shows that most North American crevice-roosting bats prefer $\frac{3}{4}$ - to 1-inch chamber spaces in bat houses that have open bottoms. These bats will, however, routinely use bat houses with a single $1\frac{1}{2}$ -inch chamber and a $\frac{3}{4}$ -inch entry. Larger species, such as pallid bats in western North America and Wagner's bonneted bat in south Florida, seem to prefer $1\frac{1}{2}$ -inch crevices. Koch found that wasps were less attracted to $\frac{3}{4}$ -inch roosting crevices.

Lisa Williams of State College, Pennsylvania, studied bat houses with Cal Butchkoski of the Pennsylvania Game

Commission. They added ventilation slots that provided wider temperature ranges, which increased use.

In hopes of attracting bats sooner, some people have painted new houses with a mixture of bat guano and water, although the effectiveness of this strategy remains unproven. Koch used guano from the same species and vicinity and consistently attracted bats the first season, while houses made of new, untreated wood were ignored until the second season. But other builders, who did not treat with guano, also attracted bats the first season, some immediately. To treat their houses, people sometimes bought bat guano or obtained it from caves. This could prove counterproductive, since droppings from one species may not attract – and might even repel – another.

Innovative bat house owners have experimented with modifications that have improved our ability to attract larger colonies.



©MERLIN D. TUTTLE, BCI / 000110

Big brown bats were found hibernating in bat houses as far north as New York. Such use may be increased by adding insulation to bat houses.

Bats in our first study seemed to prefer aged wood, so merely filling the inside of a house with slightly damp earth or rich humus and then dumping it out after a few days might work just as well.

How bats use multiple houses

THE PREVIOUSLY NOTED BENEFITS of mounting bat houses in groups of three or more, as well as the likely reasons bats prefer multiple homes, have been consistently proven by experimenters. Some report that nursery colonies frequently move their young among different houses.

This was especially well documented by Williams and Butchkoski. They placed bat houses in groups of three, a few feet apart, on the sides of buildings and carefully monitored internal temperatures. The bats moved their pups into the coolest houses on hot days and into the warmest houses on cool days. Mothers sometimes moved young back and forth even when temperature seemed not to be a factor, a phenomenon also observed by Tony Koch in his nine nursery roosts. Occasional moves may help bats evade parasites and predators.

Robert Ginn placed his Georgia bat houses in groups of three; each group included one house facing south, one facing northwest and one northeast. Twenty-six of his 29

houses were occupied. The three that remained empty were mounted singly. Close placement of two or three houses painted different colors or positioned to absorb varying amounts of solar heat appears to help attract nursery colonies and also provides excellent opportunities for studying bat temperature needs. Such groupings may prove ideal in areas where temperature requirements are poorly understood.

In the hottest climates, bats typically roost in rock or concrete crevices, which act as heat sinks to help prevent overheating. Bat biologist Patricia Brown found that lowland desert bats seldom roosted in buildings, which suggests they may not occupy bat houses in areas of intense heat. Experiments with insulation, reflective paints and heat sinks may be needed in such areas. Both pallid and free-tailed bats have used bat houses mounted on the shaded sides of stone buildings in extra-hot climates. However, at least in central Texas, freetails and cave myotis seemed to prefer houses exposed to at least six hours of daily sun.

The most successful people in our survey experimented with several bat houses before installing large numbers of them. Some doubts about the value of bat houses grew out of well-intentioned – but premature – large-scale projects. Such failures were mostly due to poor placement and lack of prior testing to evaluate the temperature needs of local bats.

Ideas for the Future

Many promising ideas remain to be tried. If you're an inventor, don't let our design suggestions limit your imagination. But remember that temperature, a secure gripping surface and safety from predators are all-important for bats, as is proximity to ample food and water.

So far, we have tried to accommodate only crevice-roosting species with the bat house designs shown in this handbook. Other bats may prefer completely different designs: long, narrow tubes, for instance, or much larger roost-chamber dimensions.

Endangered Indiana myotis and many other species roost under loose tree bark in the summer. Attracting such bats may be as simple as encircling a tree trunk with a 24- to 36-inch piece of sheet metal, plastic, fiberglass or tar paper. Attach it as tightly as possible at the top and let it flare out an inch or two at the bottom. Corrugated sheet metal, which has been wrapped around trees to protect wood duck nesting boxes from predators, has proven highly successful in attracting nursery colonies of little brown

myotis. Bats apparently move around the trunk to find the right amount of solar heating. Rocket boxes (*Figures 6 and 7 on pages 14-15*) also mimic trees with exfoliating bark and are used by many species, particularly myotis bats such as the Indiana myotis.

In lowland desert areas, where bats have difficulty finding roosts that are cool enough, you might try making bat houses out of relatively lightweight mixtures of sawdust and concrete. Such houses, developed initially for use in Europe, may be well adapted to the needs of bats that roost in desert rock crevices. Concrete houses can be formed to provide a central crevice with an open bottom.

Some highly successful houses have even been built of ¼-inch-thick plastic conduit material. These require ¾-inch vent holes to prevent overheating at midday. The vent holes are covered with plastic shields to block light. When using any white or light-colored material in construction, the interior should be painted or stained black to ensure the darkness that bats prefer.

Most European bat houses are built with bottoms. These require regular cleaning, however, and harbor more parasites than those with open bottoms. A typical painted bat house may last 10 years or more. By using open-bottom designs, even bat houses that are no longer maintained by their builders will remain available to bats for years to come.

Although more research is needed, it is encouraging that nursery houses like those in this handbook are averaging more than 80 percent occupancy when built, painted and located according to the instructions provided here.

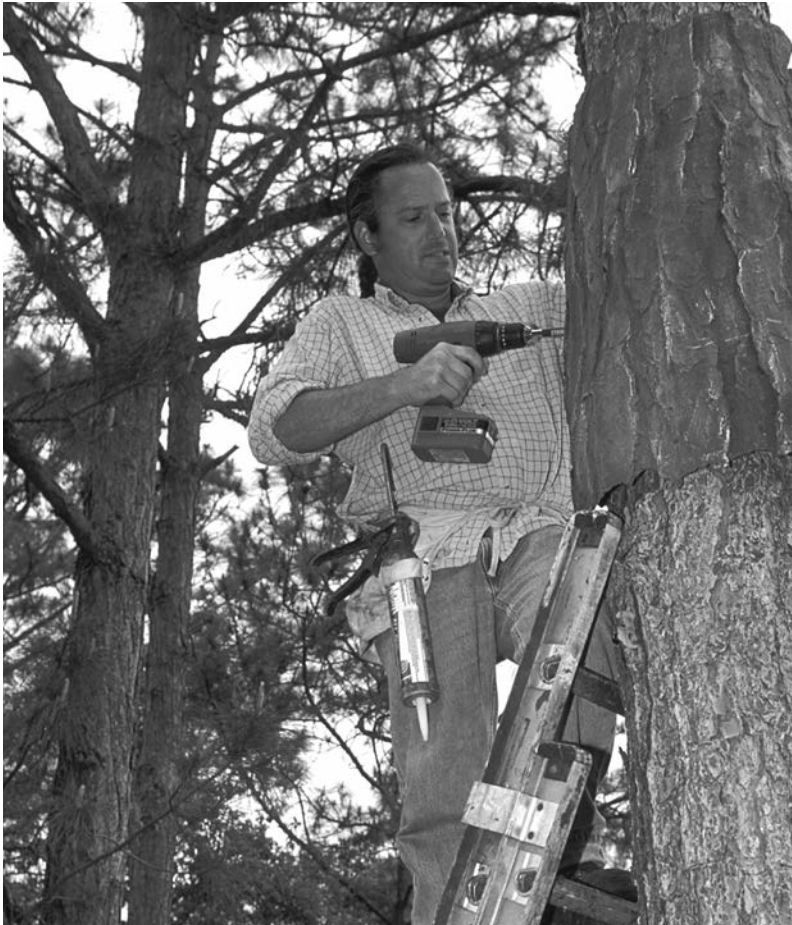

Artificial roosts (*left and above*) that mimic exfoliating tree bark can provide shelter for many forest-dwelling species. These synthetic roost structures will long outlast their natural counterparts.

Troubleshooting Your Bat House



If bats aren't moving into your bat houses, an effective strategy to learn what works best for bats in your area is to install more than one house so bats can choose from a range of colors, locations and mounts (*right*). Everything worked just right at a pecan orchard in Georgia, where this pair of triple-wide nursery houses (*left*) attracted 1,000 to 1,200 free-tailed bats.

SINCE BCI FIRST PROMOTED BAT HOUSES in the early 1980s, many other vendors have followed suit. While some have done a lot to expand public interest in bat conservation, others pay far more attention to competitive pricing than to the needs of bats. Such vendors rarely provide mounting instructions or other accurate information and often market poorly built houses that bats aren't likely to use even under the best of circumstances. When that happens, bat conservation suffers.

By experimenting with different bat house placement, crevice widths and amounts of available solar energy, you can not only have fun helping bats, but we can learn more about their needs. So if your bat house is unoccupied, experiment!

Unoccupied houses often become successful if they are

moved to receive more or less sun, stained or painted to absorb more or less heat or raised higher off the ground. When previously unsuccessful houses begin attracting bats after they are modified, we often gain especially valuable insights into the needs of bats.

If, despite providing ideal conditions, a bat house remains unoccupied, other factors must be involved. Most properly built and placed houses in our survey were occupied. But some apparently failed because local bats already had all the roosts they needed. Distances to undisturbed hibernating sites, pollution levels and the availability of food are also important factors. With the possible exception of arid areas with unusually large day-to-night temperature fluctuations, we find no evidence that any geographic region is unsuitable for successful bat houses.

By experimenting with different bat house placement, crevice widths and amounts of available solar energy, you can not only have fun helping bats, but we can learn more about their needs ...

Payoffs of Bat Conservation

BATS PLAY A VITAL ROLE in maintaining the diversity of life and the balance of nature. Most are primary predators of night-flying insects, including many that cause enormous agricultural damage. Others are essential pollinators and seed-dispersers for countless plants, especially in tropical rain forests.

Mexican free-tailed bats from just three caves near San Antonio, Texas, consume tons of insect pests nightly. The presence of insect-eating bats can sharply reduce the need for chemical pesticides. In the desert Southwest, long-nosed bats are vital pollinators of giant cacti and agaves. Worldwide, hundreds of economically important products come from bat-dependent plants, including such fruits as bananas, dates and figs.

But despite their great value, bats are widely misunderstood, feared and persecuted. Their populations are in alarming decline around the world. More than half of North America's 47 species are in decline or listed as endangered. One reason is the loss of suitable roost sites, so artificial roosts can help many bat species. In addition, White-nose Syndrome, a devastating wildlife disease, has killed more than 6 million North American bats and continues to spread.

The value of artificial roosts is well known for birds. The U.S. population of purple martins grew by more than 25 percent from 1966 to 1986, largely because of the growing use of birdhouses, while almost all other insect-eating songbirds suffered significant declines.

BCI's research has clearly documented the value of bat houses for crevice-roosting bats. Big brown bats and Mexican free-tailed bats, two of North America's most agriculturally valuable species, can live year-round in some bat houses. With more research, we may be able to increase the odds of providing year-round roosts for other species, as well.

Many people consider bat houses in hope of controlling mosquitoes and other insect pests. Bat houses alone cannot solve mosquito problems, but bats and other natural predators – birds, fish and other insects – can be effectively incorporated into integrated pest management (IPM) strategies aimed at reducing pesticide use. Such strategies should also stress the elimination of mosquito-breeding sites.

Mexican free-tailed bats (*top*) consume huge quantities of insects, including many that cause major damage to farm crops. Some species, like this lesser long-nosed bat from the American Southwest (*right*) are vital pollinators and seed-dispersers for many important plants.

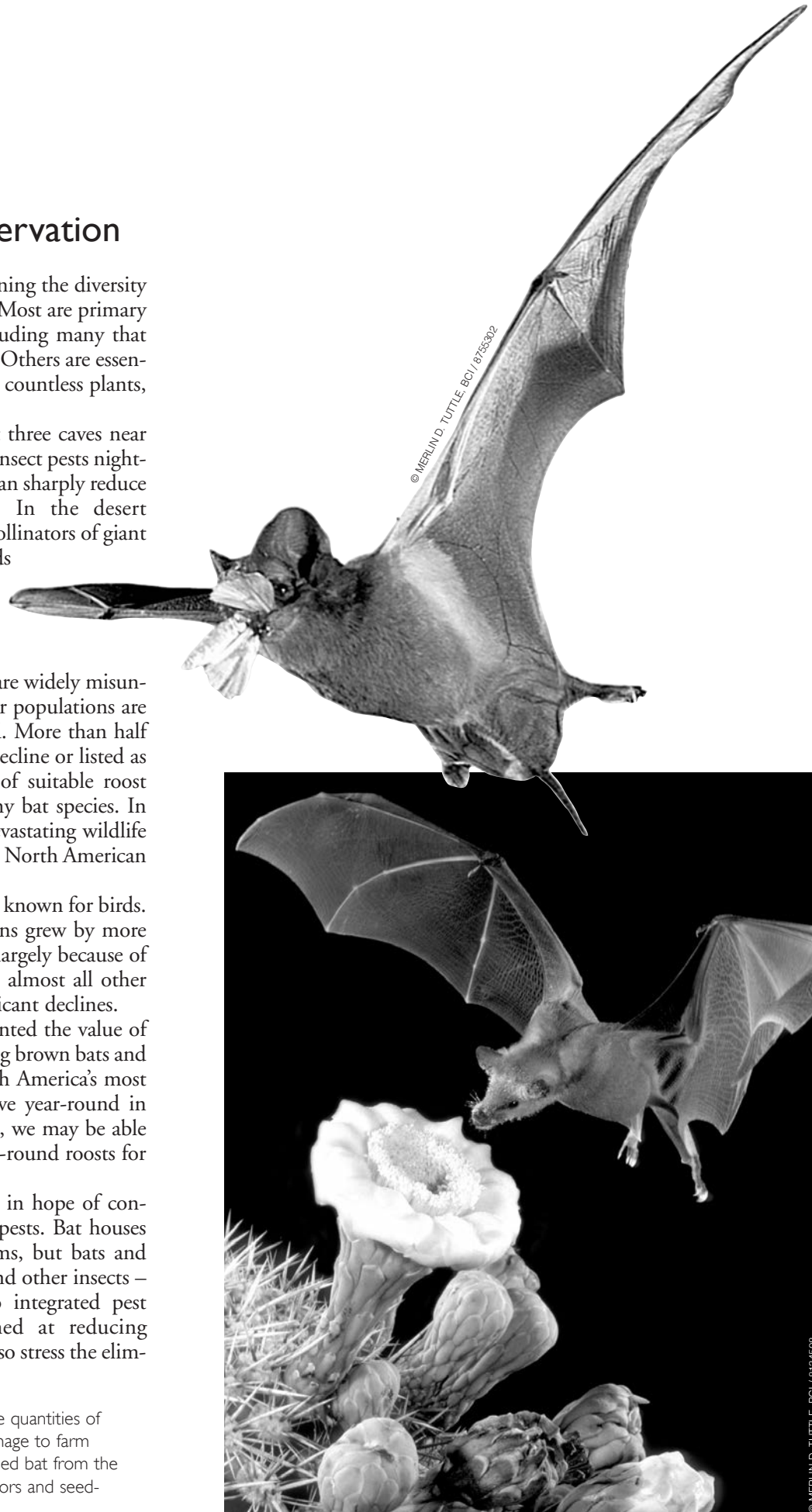

Frequently Asked Bat House Questions

WILL ATTRACTING BATS to bat houses in my yard increase the likelihood that they will move into my attic or wall spaces?

No. If bats were attracted to your attic or wall spaces and could get into them, they probably would already be living there. The best way to ensure that bats won't inhabit your home is to keep it in good repair. Bats can enter spaces as small as one-half inch in diameter.

If I have bats living in my attic but would prefer that they occupy a bat house instead, what should I do?

Attics and other parts of buildings often provide ideal bat-roosting sites. In most cases, bats will not voluntarily move from an attic. In such cases, alternative roosts ideally should be provided several months or one season before the desired move.

The bats should be excluded from the attic at a time in the early spring or late fall when flightless young are not present.

Permanently and humanely evicting bats from buildings is usually not particularly difficult, but it requires patience and attention to detail. Exclusions can sometimes be performed by homeowners following guidelines available on our website. You can watch to see where the bats emerge at dusk and use exclusion tubes to create one-way exits.

For detailed information on excluding bats and bats and buildings issues, visit www.batcon.org/buildings.

How many bats can potentially occupy my bat house?

Depending on the size and the number of chambers, your bat house might shelter fewer than 50 to as many as several hundred bats. A very large "community bat house" might attract thousands.

Can bats be introduced into areas where they do not already live?

If appropriate bat species pass through your general area, putting up a bat house may attract a colony, but there is nothing you can do to introduce them artificially. Bats have strong homing instincts and would probably return to their original roost.

Catching or purchasing bats (which is often illegal) for introduction into a new bat house should not be attempted. At the current time, there are no proven lures or attrac-

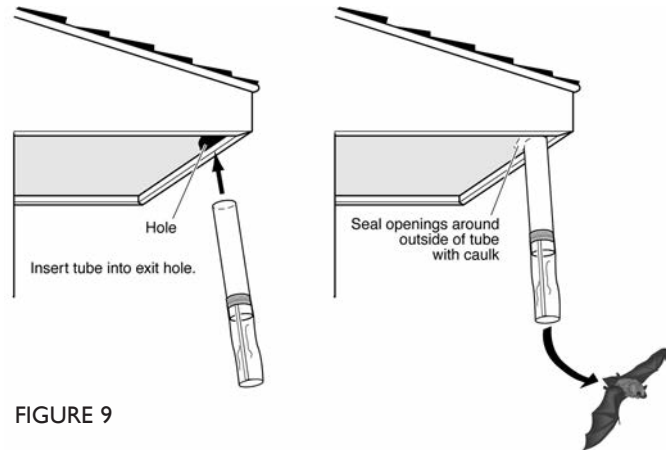

FIGURE 9

Bat houses are often installed as alternative homes for bats roosting in walls or attics. Excluding bats from buildings requires establishing one-way exits through which the bats can leave but cannot return, while also sealing all other potential entry points. Exclusions should not be conducted between April and late August, when pups might be trapped inside. In most cases, tubes make the best bat-exclusion devices. The tubes should be about two inches in diameter and 10 inches long. They can be purchased commercially or made from PVC pipe or other materials. Exclusion techniques are described in detail on BCI's website: www.batcon.org/buildings.

tants that will entice bats into occupying a bat house.

How can I determine the likelihood of attracting bats?

Most North American bats prefer to live within a few hundred yards of fresh water, especially streams, rivers or lakes. In some western areas, even swimming pools or small cattle tanks that provide open water may be sufficient. All bats, especially nursery colonies, require good feeding habitat; riparian areas (along rivers or lakes) are typically best. Exceptionally high bat house success has been achieved in areas that support varied agriculture, especially orchards and natural woodlots or other vegetation near water.

Areas where bats already have attempted to live in buildings are a good bet, and in northern areas, the nearer they are to potential hibernating sites in caves or abandoned mines, the better.

Why might bats not be attracted to my bat house?

It may not be well built, which usually means a failure to: 1) provide $\frac{3}{4}$ -inch roosting crevices that are at least 20 inches tall and 14 inches wide; 2) carefully caulk and paint; or 3) include ventilation slots. Also, even well-built houses must be positioned and painted an appropriate color for



With their voracious appetite for beetles, bugs and leafhoppers, big brown bats are among farmers' best allies in reducing agricultural pests.

adequate solar heating, and they should be as safe as possible from climbing predators.

If your bat house meets construction, mounting and habitat criteria and still has not attracted bats by the end of its second full spring-summer season, try moving it to a spot with more or less sun. Such moves have dramatically improved success rates for many bat house owners.

Some areas simply do not provide adequate food, water or hibernation sites and will not support bats.

Alternatively, bats may sometimes have all the roosts they need and aren't likely to move until they lose an existing roost or you provide a better home than the one they already have. This is where patient testing comes into play. So far, we are unaware of any large areas in North America (with the possible exception of some unusually hot desert lowlands) where bats have not been attracted to bat houses.

How effective are bats in controlling insects?

As primary predators of night-flying insects, bats play a key role in the balance of nature. They consume vast quantities of insects, including many agricultural and backyard pests. Bats are excellent predators of moths, which produce such costly larval pests as cutworms, corn earworms and armyworms.

Organic farmer Tony Koch reported a reduction of corn earworms from an average of several per ear of corn to none after he attracted about 2,000 little brown myotis to 24 bat

houses on his Oregon farm. Many insect pests are able to hear the ultrasonic calls of echolocating bats and will avoid areas where bats are active.

Bat biologist John Whitaker documented that a single colony of 150 big brown bats, which could easily live in one bat house, can eliminate 38,000 cucumber beetles, 16,000 June beetles, 19,000 stinkbugs and 50,000 leafhoppers each summer. This conservative estimate does not consider the many other insects these bats eat.

Cucumber beetles are among America's most costly agricultural pests. Adults attack corn, spinach and various vine plants, but the greatest harm comes from their larvae, known as corn rootworms. Whitaker concluded that by eating 38,000 cucumber beetles, the bats protected local farmers from approximately 33 million rootworm larvae that the beetles would have produced.

To appreciate the incredible impact bats can have, consider that the millions of Mexican free-tailed bats that spend summers in Bracken Cave, Texas, consume tons of insects each night while hunting over surrounding towns and croplands. Loss of such bats would leave us increasingly dependent on chemical alternatives that already threaten our personal and environmental health.

Will having bat houses in my yard interfere with attracting birds?

No. They rarely compete for food or space.

Will bat droppings pose a health threat to my family?

No more so than bird or cat droppings would. Inhalation of dust associated with animal feces of any kind should be avoided.

What are the chances that a sick bat will endanger my family with rabies?

Like all mammals, bats can contract rabies, although very few of them do. Unlike many other animals, even rabid bats rarely become aggressive. Infected bats die from the disease, and outbreaks in their colonies are extremely rare. The odds of being harmed by a rabid bat are remote if you simply do not attempt to handle bats or any other wild animal. Any bat that appears easy to catch should be assumed to be sick and left alone. All animal bites should be reported immediately to a medical professional.

From 1951 through 2012, 54 Americans are believed to have contracted rabies from bats in the United States. With or without bats in your yard, the most important action you can take to protect your family from rabies is to vaccinate your family dogs and cats.

Bats Most Likely to Occupy Bat Houses in the United States and Canada

Throughout the northern two-thirds of the United States and southern Canada, the little brown myotis and big brown bat are the most likely species to be encountered in bat houses. In the southern United States, Mexican free-

tailed, southeastern myotis and evening bats are most common. Almost any bat that will roost in buildings or under bridges is a candidate for a bat house. These species have been documented as bat house users:



Pallid bat, *Antrozous pallidus*

Western and southwestern United States and extreme south-central British Columbia, mostly in arid areas. Found in rock crevices, buildings, under bridges and in bat houses. Winter habitat unknown, presumed to hibernate locally in deep rock crevices.



Big brown bat, *Eptesicus fuscus*

Most of the United States and Canada, except for extreme southern Florida and south and central Texas. Rears young in tree hollows, bridges, buildings, and bat houses. Hibernates in caves, abandoned mines and buildings. Frequent bat house users, they have overwintered in bat houses from Texas to New York.



Florida bonneted bat, *Eumops floridanus*

Southern Florida only. Extremely rare and listed as Critically Endangered by the IUCN. Roosts in Spanish tile roofs, as well as palm fronds and woodpecker holes. The species has been documented in a number of bat houses in southwestern Florida. At least one maternity colony was confirmed using a bat house with a 1½-inch chamber.



Pallas's mastiff bat, *Molossus molossus*

In the United States, found in buildings in the Florida Keys only. Throughout the Caribbean, northern Mexico, Central America and northern South America, its roosts include hollow trees, palm fronds, rock crevices, caves, bridges, culverts and buildings. Uses bat houses year-round in Cayman Islands and Puerto Rico.

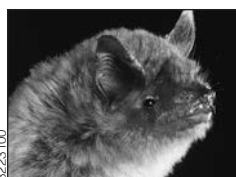

Southeastern myotis, *Myotis austroriparius*

Mostly restricted to Gulf Coast states. Rears young in caves, tree hollows, buildings, bridges and bat houses. Often nonmigratory, hibernates in caves in its northern range and sometimes in tree hollows or buildings farther south. Confirmed bat house user in Florida and Georgia; believed to use bat houses in other Gulf states.



Long-eared myotis, *Myotis evotis*

Primarily in forests of southwestern Canada and the western United States. Often lives alone or in small groups; females form small maternity colonies in summer. Roosts in hollow trees, under bark, in cliff crevices, caves, mines and abandoned buildings. Confirmed bat house user in Washington. Winter habitat unknown.



Little brown myotis, *Myotis lucifugus*

Wooded areas throughout most of Canada and the northern half of the United States, except desert and arid areas. A few isolated populations farther south. Rears young in tree hollows, buildings, rock crevices and bat houses. Travels to nearest suitable cave or abandoned mine for hibernation. This is one of the species most commonly found in bat houses.

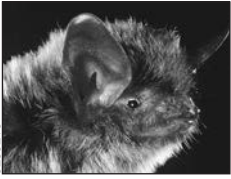

8296218

Northern myotis, *Myotis septentrionalis*

Upper Midwest, eastern, and some southern states and into Canada. Summer roosts vary. Northern myotis have been found beneath tree bark, in buildings and in caves. Little is known about nursery colonies, but small numbers have been found rearing young beneath tree bark, in buildings and in bat houses. Hibernates in rock crevices, caves and mines.



8296202

Indiana myotis, *Myotis sodalis*

Endangered species associated mainly with forests and limestone caves in the eastern United States. Maternity colonies mainly roost beneath loose bark. Most hibernate in about eight caves and mines in three states. Occasionally uses buildings, bridges and bat houses; reported in bat houses in Illinois, Indiana and Pennsylvania.



8304104

Cave myotis, *Myotis velifer*

Southern California and Arizona into central Texas, Oklahoma and south-central Kansas. Forms large nursery colonies in caves and rears young in smaller groups in buildings. The eastern subspecies hibernates in caves, but the winter habitat of the western subspecies is unknown. Shares bat houses with Mexican free-tailed bats in Texas.



8305207

Yuma myotis, *Myotis yumanensis*

Southern British Columbia, Washington, Idaho, Oregon, California, Arizona, extreme western Nevada, eastern Utah, southern Wyoming to western New Mexico. Restricted to areas near water. Rears young in caves, in buildings, under bridges and in bat houses. Winter habitat unknown. Lives in bat houses from Arizona to British Columbia.



8311201

Evening bat, *Nycticeius humeralis*

East of the Appalachians, ranges from southern Pennsylvania to Florida; west of the mountains, from southern Michigan and Wisconsin into Nebraska and south into Texas. Rears young in buildings, tree cavities and bat houses. Nursery colonies often share roosts with Mexican free-tailed bats. Winter habitat largely unknown, but often found in buildings and bat houses.



8321502

Tri-colored bat, *Perimyotis subflavus*

Eastern North America into Canada, except northern Maine, and south to Texas and central Florida. Little is known about summer roosts; sometimes rears young in tree foliage or in buildings. Several tri-colored bats have been reported in bat houses. Hibernates in caves.



8038401

Mexican free-tailed bat, *Tadarida brasiliensis*

Common in southern and southwestern United States and north to Nebraska, Colorado, Utah, Nevada and Oregon. Rears young in caves, buildings, bridges and bat houses. Frequent bat house user. Many populations migrate south to overwinter in Mexico and Central America, although colonies in the southeastern U.S. and West Coast typically do not migrate. Active year round.

PHOTOS © MERLIN D. TUTTLE, BCI

More information

To learn more about bats, particularly those that might occupy your bat house, visit BCI's website:
www.batcon.org.



© MERLIN D. TUTTLE, BCI \ 8402215

Bats Need Your Help!

Join Bat Conservation International

BAT CONSERVATION INTERNATIONAL WAS FOUNDED IN 1982, as scientists around the world became alarmed by severe declines in bat populations. Most conservation groups had long neglected bats, while animals with more public appeal, although often less ecological importance, were well-represented. Yet bats, as primary predators of night-flying insects and essential pollinators and seed-dispersers for countless plants, play a vital role in maintaining our environmental and economic health.

Today, BCI is recognized as the international leader in conservation initiatives that protect bats and their habitats. BCI is a primary resource for providing a broad range of expertise about bats to conservation planners, environmental educators, government agencies and many other people and organizations.

Although bat conservation remains one of the greatest conservation challenges, much progress is being made. As a result of BCI's educational efforts, millions of people worldwide are beginning to understand and appreciate bats. Key nursery and hibernation caves containing millions of American bats are being protected, and international research is being funded to document bat values and needs.

But now much of that progress is at risk in North America: millions of hibernating bats are being killed by a devastating wildlife disease called White-nose Syndrome that was discovered in a New York State cave in February 2006. As it spreads across eastern North America and beyond, mortality rates approach 100 percent at some hibernation sites and once-common species are at risk of regional extinction.

Bats need our help now more than ever. Please join us. BCI members have the satisfaction of knowing that their conservation dollars are making a real difference. Members receive *BATS*, our quarterly magazine with spectacular photography and informative articles by the world's leading bat biologists and others about bat behavior, conservation progress and projects that your contributions are funding.

Bats and the habitats that rely on them urgently need your assistance. Please join us and help save these remarkable and vulnerable animals.

To join Bat Conservation International, please visit our website: www.batcon.org



batcon.org
BAT CONSERVATION
INTERNATIONAL



Distributed by
University of Texas Press
PO Box 7819
Austin, TX 78713-7819

ISBN 0-9742379-1-4

90000

9 780974 237916